

**SONY**<sup>®</sup>

4-446-733-12(1)

Blu-ray Disc™/  
DVD Home Theatre  
System

**Operating Instructions**

## WARNING

Do not install the appliance in a confined space, such as a bookcase or built-in cabinet. To reduce the risk of fire, do not cover the ventilation opening of the appliance with newspapers, tablecloths, curtains, etc. Do not expose the appliance to naked flame sources (for example, lighted candles). Do not expose batteries or appliances with battery-installed to excessive heat, such as sunshine and fire. To prevent injury, this apparatus must be securely attached to the floor/wall in accordance with the installation instructions. Indoor use only.

## CAUTION

The use of optical instruments with this product will increase eye hazard. As the laser beam used in this Blu-ray Disc/DVD Home Theatre System is harmful to eyes, do not attempt to disassemble the cabinet. Refer servicing to qualified personnel only.

CAUTION	CLASS 3R VISIBLE AND INVISIBLE LASER RADIATION WHEN OPEN. AVOID DIRECT EYE EXPOSURE.
VORSICHT	KLASSE 3R SICHTBARE UND UNSICHTBARE LASERSTRÄHLUNG WENN GESÖFFNET. UNMITTELBAREN AUGENKONTAKT VERMEIDEN.
ADVARSEL	SYNLIG OG USYNLIG LASERSTRÅLING AF KLASSE 3R VED ÅBNING. UNDGÅ AT SE DIREKTE PÅ STRÅLEN.
ADVARSEL	SYNLIG OG USYNLIG LASERSTRÅLING I KLASSE 3R NÄR DEKSEL ÅPNS. UNNGÅ DIREKTE EXPOSERING AV ÖYENNE.
VARNING	KLASSE 3R SYNLIG OCH OSYNLIG LASERSTRÅLNING NÄR DENNA DEL ÄR ÖPPNAD. UNDVIK ATT DIREKT EXPONERA ÖGONEN FÖR STRÅLNINGEN.
VARO!	AVATTUNA LUOKAN 3R NÄKYVÄÄ JA NÄKYMÄTÖNTÄ LASERSÄTELYÄ. VÄLTÄ KATSEEN SUORAA ALITSTAVASTA.
警告	打开时有3类可见和不可见激光辐射，避免眼睛受到直射的照射
注意	打開時有第3類可見及不可見雷射輻射，避免眼睛直接暴露。

Pick-up unit of this appliance is classified as a CLASS 3R LASER product. Visible and invisible laser radiation is emitted when the laser protective housing is opened, so be sure to avoid direct eye exposure. This marking is located on the laser protective housing inside the enclosure.

CLASS 1 LASER PRODUCT  
LASER KLASSE 1  
LUOKAN 1 LASERLAITE  
KLASS 1 LASERAPPARAT  
1类激光产品  
第1類雷射產品

This appliance is classified as a CLASS 1 LASER product. This marking is located on the rear exterior. The nameplate is located on the bottom exterior.

## For the customers in the U.S.A.

To reduce the risk of fire or electric shock, do not expose this apparatus to rain or moisture.

These following indications are located on the rear exterior.



This symbol is intended to alert the user to the presence of uninsulated “dangerous voltage” within the product’s enclosure that may be of sufficient magnitude to constitute a risk of electric shock to persons.



This symbol is intended to alert the user to the presence of important operating and maintenance (servicing) instructions in the literature accompanying the appliance.

## Owner’s Record

The model and serial numbers are located on the bottom exterior of the unit. Record these numbers in the space provided below. Refer to them whenever you call upon your Sony dealer regarding this product.

Model No. \_\_\_\_\_

Serial No. \_\_\_\_\_

The following FCC statement applies only to the version of this model manufactured for sale in the U.S.A. Other versions may not comply with FCC technical regulations.

#### NOTE:

This equipment has been tested and found to comply with the limits for a Class B digital device, pursuant to Part 15 of the FCC Rules. These limits are designed to provide reasonable protection against harmful interference in a residential installation. This equipment generates, uses, and can radiate radio frequency energy and, if not installed and used in accordance with the instructions, may cause harmful interference to radio communications. However, there is no guarantee that interference will not occur in a particular installation. If this equipment does cause harmful interference to radio or television reception, which can be determined by turning the equipment off and on, the user is encouraged to try to correct the interference by one or more of the following measures:

- Reorient or relocate the receiving antenna (aerial).
- Increase the separation between the equipment and receiver.
- Connect the equipment into an outlet on a circuit different from that to which the receiver is connected.
- Consult the dealer or an experienced radio/TV technician for help.

#### CAUTION

You are cautioned that any changes or modifications not expressly approved in this manual could void your authority to operate this equipment.

Properly shielded and grounded cables and connectors must be used for connection to host computers and/or peripherals in order to meet FCC emission limits.

#### Blu-ray Disc/DVD receiver (HBD-E6100/HBD-E4100/ HBD-E3100/HBD-E2100)

This equipment must not be co-located or operated in conjunction with any other antenna or transmitter.

This equipment complies with FCC radiation exposure limits set forth for an uncontrolled environment and meets the FCC radio frequency (RF) Exposure Guidelines in Supplement C to OET65.

This equipment should be installed and operated keeping the radiator at least 20cm or more away from person's body (excluding extremities: hands, wrists, feet and ankles).

#### Important Safety Instructions

- 1) Read these instructions.
- 2) Keep these instructions.
- 3) Heed all warnings.
- 4) Follow all instructions.
- 5) Do not use this apparatus near water.
- 6) Clean only with dry cloth.
- 7) Do not block any ventilation openings. Install in accordance with the manufacturer's instructions.
- 8) Do not install near any heat sources such as radiators, heat registers, stoves, or other apparatus (including amplifiers) that produce heat.
- 9) Do not defeat the safety purpose of the polarized or grounding-type plug. A polarized plug has two blades with one wider than the other. A grounding type plug has two blades and a third grounding prong. The wide blade or the third prong are provided for your safety. If the provided plug does not fit into your outlet, consult an electrician for replacement of the obsolete outlet.
- 10) Protect the power cord from being walked on or pinched particularly at plugs, convenience receptacles, and the point where they exit from the apparatus.
- 11) Only use attachments/accessories specified by the manufacturer.

- 12) Use only with the cart, stand, tripod, bracket, or table specified by the manufacturer, or sold with the apparatus. When a cart is used, use caution when moving the cart/apparatus combination to avoid injury from tip-over.



- 13) Unplug this apparatus during lightning storms or when unused for long periods of time.
- 14) Refer all servicing to qualified service personnel. Servicing is required when the apparatus has been damaged in any way, such as power-supply cord or plug is damaged, liquid has been spilled or objects have fallen into the apparatus, the apparatus has been exposed to rain or moisture, does not operate normally, or has been dropped.

## For the customers in Canada

To reduce the risk of fire or electric shock, do not expose this appliance to dripping or splashing, and do not place objects filled with liquids, such as vases, on the appliance.

The serial number is located on the bottom exterior.

Properly shielded and grounded cables and connectors must be used for connection to host computers and/or peripherals.

### Blu-ray Disc/DVD receiver (HBD-E6100/HBD-E4100/ HBD-E3100/HBD-E2100)

This device complies with Industry Canada licence-exempt RSS standard(s). Operation is subject to the following two conditions:

- (1) this device may not cause interference, and
- (2) this device must accept any interference, including interference that may cause undesired operation of this device.

This equipment complies with IC radiation exposure limits set forth for an uncontrolled environment and meets RSS-102 of the IC radio frequency (RF) Exposure rules. This equipment should be installed and operated keeping the radiator at least 20cm or more away from person's body (excluding extremities: hands, wrists, feet and ankles).

## Precautions

### On power sources

- The unit is not disconnected from the mains as long as it is connected to the AC outlet, even if the unit itself has been turned off.
- As the main plug is used to disconnect the unit from the mains, connect the unit to an easily accessible AC outlet. Should you notice an abnormality in the unit, disconnect the main plug from the AC outlet immediately.

### On watching 3D video images

Some people may experience discomfort (such as eye strain, fatigue, or nausea) while watching 3D video images. Sony recommends that all viewers take regular breaks while watching 3D video images. The length and frequency of necessary breaks will vary from person to person. You must decide what works best. If you experience any discomfort, you should stop watching the 3D video images until the discomfort ends; consult a doctor if you believe necessary. You should also review (i) the instruction manual and/or the caution message of any other device used with, or Blu-ray Disc contents played with this product and (ii) our website (<http://esupport.sony.com/>) for the latest information. The vision of young children (especially those under six years old) is still under development. Consult your doctor (such as a pediatrician or eye doctor) before allowing young children to watch 3D video images.

Adults should supervise young children to ensure they follow the recommendations listed above.

## Copy Protection

- Please be advised of the advanced content protection systems used in both Blu-ray Disc and DVD media. These systems, called AACS (Advanced Access Content System) and CSS (Content Scramble System), may contain some restrictions on playback, analog output, and other similar features. The operation of this product and the restrictions placed may vary depending on the date of purchase, as the governing board of the AACS may adopt or change its restriction rules after the time of purchase.

### Cinavia Notice

This product uses Cinavia technology to limit the use of unauthorized copies of some commercially-produced film and videos and their soundtracks. When a prohibited use of an unauthorized copy is detected, a message will be displayed and playback or copying will be interrupted.

More information about Cinavia technology is provided at the Cinavia Online Consumer Information Center at <http://www.cinavia.com>. To request additional information about Cinavia by mail, send a postcard with your mailing address to: Cinavia Consumer Information Center, P.O. Box 86851, San Diego, CA, 92138, USA.

## Copyrights and Trademarks

- This system incorporates with Dolby\* Digital and Dolby Pro Logic adaptive matrix surround decoder and the DTS\*\* Digital Surround System.

\* Manufactured under license from Dolby Laboratories. Dolby, Pro Logic, and the double-D symbol are trademarks of Dolby Laboratories.

\*\* Manufactured under license under U.S. Patent Nos: 5,956,674; 5,974,380; 6,226,616; 6,487,535; 7,212,872; 7,333,929; 7,392,195; 7,272,567 & other U.S. and worldwide patents issued & pending. DTS-HD, the Symbol, & DTS-HD and the Symbol together are registered trademarks of DTS, Inc. Product includes software. © DTS, Inc. All Rights Reserved.

- This system incorporates High-Definition Multimedia Interface (HDMI<sup>TM</sup>) technology. The terms HDMI and HDMI High-Definition Multimedia Interface, and the HDMI Logo are trademarks or registered trademarks of HDMI Licensing LLC in the United States and other countries.
- Java is a trademark of Oracle and/or its affiliates.
- “DVD logo” is a trademark of DVD Format/Logo Licensing Corporation.
- “Blu-ray Disc”, “Blu-ray”, “Blu-ray 3D”, “BD-LIVE”, “BONUSVIEW”, and logos are trademarks of the Blu-ray Disc Association.
- “Blu-ray Disc”, “DVD+RW”, “DVD-RW”, “DVD+R”, “DVD-R”, “DVD VIDEO”, and “CD” logos are trademarks.
- “BRAVIA” is a trademark of Sony Corporation.
- “AVCHD 3D/Progressive” and the “AVCHD 3D/Progressive” logo are trademarks of Panasonic Corporation and Sony Corporation.
- “XMB”, and “cross media bar” are trademarks of Sony Corporation and Sony Computer Entertainment Inc.
- “PlayStation” is a registered trademark of Sony Computer Entertainment Inc.
- “Sony Entertainment Network logo” and “Sony Entertainment Network” are trademarks of Sony Corporation.

- Music and video recognition technology and related data are provided by Gracenote<sup>®</sup>. Gracenote is the industry standard in music recognition technology and related content delivery. For more information, please visit [www.gracenote.com](http://www.gracenote.com).

CD, DVD, Blu-ray Disc, and music and video-related data from Gracenote, Inc., copyright © 2000-present Gracenote. Gracenote Software, copyright © 2000-present Gracenote. One or more patents owned by Gracenote apply to this product and service. See the Gracenote website for a nonexhaustive list of applicable Gracenote patents. Gracenote, CDDB, MusicID, the Gracenote logo and logotype, and the “Powered by Gracenote” logo are either a registered trademark or a trademark of Gracenote, Inc. in the United States and/or other countries.



- Wi-Fi<sup>®</sup>, Wi-Fi Protected Access<sup>®</sup> and Wi-Fi Alliance<sup>®</sup> are registered marks of the Wi-Fi Alliance.
- Wi-Fi CERTIFIED<sup>™</sup>, WPA<sup>™</sup>, WPA2<sup>™</sup> and Wi-Fi Protected Setup<sup>™</sup> are marks of the Wi-Fi Alliance.
- The N Mark is a trademark or registered trademark of NFC Forum, Inc. in the United States and in other countries.
- Android is a trademark of Google Inc.
- The Bluetooth<sup>®</sup> word mark and logos are registered trademarks owned by Bluetooth SIG, Inc. and any use of such marks by Sony Corporation is under license. Other trademarks and trade names are those of their respective owners.
- MPEG Layer-3 audio coding technology and patents licensed from Fraunhofer IIS and Thomson.

- This product incorporates proprietary technology under license from Verance Corporation and is protected by U.S. Patent 7,369,677 and other U.S. and worldwide patents issued and pending as well as copyright and trade secret protection for certain aspects of such technology. Cinavia is a trademark of Verance Corporation. Copyright 2004-2010 Verance Corporation. All rights reserved by Verance. Reverse engineering or disassembly is prohibited.

- Windows Media is either a registered trademark or trademark of Microsoft Corporation in the United States and/or other countries.

This product is protected by certain intellectual property rights of Microsoft Corporation. Use or distribution of such technology outside of this product is prohibited without a license from Microsoft or an authorized Microsoft subsidiary. Content owners use Microsoft<sup>®</sup>

PlayReady<sup>™</sup> content access technology to protect their intellectual property, including copyrighted content. This device uses PlayReady technology to access PlayReady-protected content and/or WMDRM-protected content. If the device fails to properly enforce restrictions on content usage, content owners may require Microsoft to revoke the device's ability to consume PlayReady-protected content. Revocation should not affect unprotected content or content protected by other content access technologies. Content owners may require you to upgrade PlayReady to access their content. If you decline an upgrade, you will not be able to access content that requires the upgrade.

- DLNA<sup>™</sup>, the DLNA Logo and DLNA CERTIFIED<sup>™</sup> are trademarks, service marks, or certification marks of the Digital Living Network Alliance.

- Opera® Devices SDK from Opera Software ASA. Copyright 1995 - 2013 Opera Software ASA. All rights reserved.



- All other trademarks are trademarks of their respective owners.
- Other system and product names are generally trademarks or registered trademarks of the manufacturers.™ and ® marks are not indicated in this document.

## End User License Information

### Gracenote® End User License Agreement

This application or device contains software from Gracenote, Inc. of Emeryville, California (“Gracenote”). The software from Gracenote (the “Gracenote Software”) enables this application to perform disc and/or file identification and obtain music-related information, including name, artist, track, and title information (“Gracenote Data”) from online servers or embedded databases (collectively, “Gracenote Servers”) and to perform other functions. You may use Gracenote Data only by means of the intended End-User functions of this application or device.

You agree that you will use Gracenote Data, the Gracenote Software, and Gracenote Servers for your own personal non-commercial use only. You agree not to assign, copy, transfer or transmit the Gracenote Software or any Gracenote Data to any third party. **YOU AGREE NOT TO USE OR EXPLOIT GRACENOTE DATA, THE GRACENOTE SOFTWARE, OR GRACENOTE SERVERS, EXCEPT AS EXPRESSLY PERMITTED HEREIN.**

You agree that your non-exclusive license to use the Gracenote Data, the Gracenote Software, and Gracenote Servers will terminate if you violate these restrictions. If your license terminates, you agree to cease any and all use of the Gracenote Data, the Gracenote Software, and Gracenote Servers. Gracenote reserves all rights in Gracenote Data, the Gracenote Software, and the Gracenote Servers, including all ownership rights. Under no circumstances will Gracenote become liable for any payment to you for any information that you provide. You agree that Gracenote, Inc. may enforce its rights under this Agreement against you directly in its own name.

The Gracenote service uses a unique identifier to track queries for statistical purposes. The purpose of a randomly assigned numeric identifier is to allow the Gracenote service to count queries without knowing anything about who you are. For more information, see the web page for the Gracenote Privacy Policy for the Gracenote service.

The Gracenote Software and each item of Gracenote Data are licensed to you “AS IS.” Gracenote makes no representations or warranties, express or implied, regarding the accuracy of any Gracenote Data from in the Gracenote Servers. Gracenote reserves the right to delete data from the Gracenote Servers or to change data categories for any cause that Gracenote deems sufficient. No warranty is made that the Gracenote Software or Gracenote Servers are error-free or that functioning of Gracenote Software or Gracenote Servers will be uninterrupted. Gracenote is not obligated to provide you with new enhanced or additional data types or categories that Gracenote may provide in the future and is free to discontinue its services at any time.

GRACENOTE DISCLAIMS ALL WARRANTIES EXPRESS OR IMPLIED, INCLUDING, BUT NOT LIMITED TO, IMPLIED WARRANTIES OF MERCHANTABILITY, FITNESS FOR A PARTICULAR PURPOSE, TITLE, AND NON-INFRINGEMENT. GRACENOTE DOES NOT WARRANT THE RESULTS THAT WILL BE OBTAINED BY YOUR USE OF THE GRACENOTE SOFTWARE OR ANY GRACENOTE SERVER. IN NO CASE WILL GRACENOTE BE LIABLE FOR ANY CONSEQUENTIAL OR INCIDENTAL DAMAGES OR FOR ANY LOST PROFITS OR LOST REVENUES.

© Gracenote, Inc. 2009

---

## About These Operating Instructions

- The instructions in these Operating Instructions describe the controls on the remote control. You can also use the controls on the unit if they have the same or similar names as those on the remote control.
- In this manual, “disc” is used as a general reference for BDs, DVDs, or CDs unless otherwise specified by the text or illustrations.
- The instructions in this manual are for BDV-E6100, BDV-E4100, BDV-E3100, and BDV-E2100. BDV-E6100 is the model used for illustration purposes. Any difference in operation is clearly indicated in the text, for example, “BDV-E6100 only”.
- Some illustrations are presented as conceptual drawings, and may be different from the actual products.
- The items displayed on the TV screen may vary depending on the area.
- The default setting is underlined.



# Table of Contents

About These Operating Instructions ....	8
Unpacking .....	10
Guide to Parts and Controls .....	13

## Getting Started

<b>Step 1: Installing the Speakers</b> .....	<b>17</b>
<b>Step 2: Connecting the System</b> .....	<b>18</b>
<b>Connecting the speakers</b> .....	<b>18</b>
<b>Connecting the TV</b> .....	<b>19</b>
<b>Connecting the other equipment</b> .....	<b>20</b>
<b>Connecting the antenna (aerial)</b> .....	<b>21</b>
<b>Step 3: Preparing for Network Connection</b> .....	<b>21</b>
<b>Step 4: Performing the Easy Setup</b> .....	<b>23</b>
<b>Step 5: Selecting the Playback Source</b> .....	<b>24</b>
<b>Step 6: Enjoying Surround Sound</b> .....	<b>24</b>

## Playback

Playing a Disc .....	26
Playing from a USB Device .....	28
Enjoying music from a <i>Bluetooth</i> device .....	28
Connecting to a smartphone by One-touch listening function (NFC) .....	30
Playing via a Network .....	32
Available Options .....	35

## Sound Adjustment

Selecting the Audio Format, Multilingual Tracks, or Channel .....	37
Enjoying Multiplex Broadcast Sound .....	38

## Tuner

Listening to the Radio .....	38
------------------------------	----

## Other Operations

Using the Control for HDMI Function for “BRAVIA” Sync .....	40
Setting the Speakers .....	40
Using the Sleep Timer .....	42
Deactivating the Buttons on the Unit .....	42
Controlling Your TV with the Supplied Remote Control .....	42
Saving Power in Standby Mode .....	43
Browsing Websites .....	43

## Settings and Adjustments

Using the Setup Display .....	45
[Network Update] .....	46
[Screen Settings] .....	46
[Audio Settings] .....	48
[BD/DVD Viewing Settings] .....	49
[Parental Control Settings] .....	49
[System Settings] .....	50
[Network Settings] .....	51
[Easy Network Settings] .....	52
[Resetting] .....	52

## Additional Information

Precautions .....	52
Notes about Discs .....	55
Troubleshooting .....	55
Playable Discs .....	60
Playable Types of Files .....	61
Supported Audio Formats .....	63
Specifications .....	63
Language Code List .....	66
Index .....	68

# Unpacking

- Operating Instructions
- Quick Setup Guide
- Speaker Installation Guide
- Remote control (1)
- R6 (size AA) batteries (2)
- FM wire antenna (aerial) (1)

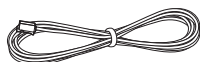

## BDV-E6100 only

- Front speakers (2)



- Surround speakers (2)



- Center speaker (1)

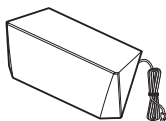

- Subwoofer (1)

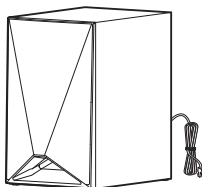

- Speaker-bottom covers (4)



- Bases (4)



- Lower parts of the front and surround speakers (4)



- Screws (large) (4)



- Screws (small) (16)



### BDV-E4100 only

- Front speakers (2)



- Surround speakers (2)



- Center speaker (1)

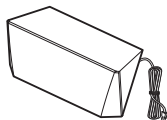

- Subwoofer (1)

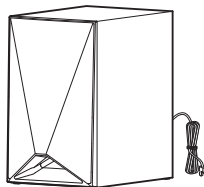

- Speaker-bottom covers (2)



- Bases (2)



- Lower parts of the front speakers (2)



- Screws (large) (2)



- Screws (small) (8)



### BDV-E3100 only

- Front speakers (2)



- Surround speakers (2)



- Center speaker (1)

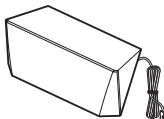

- Subwoofer (1)

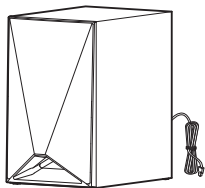

**BDV-E2100 only**

- Front speakers (2)

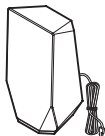

- Surround speakers (2)

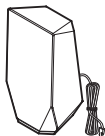

- Center speaker (1)

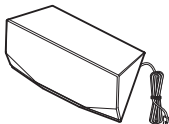

- Subwoofer (1)

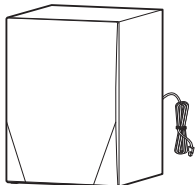

# Guide to Parts and Controls

For more information, refer to the pages indicated in parentheses.

## Front panel

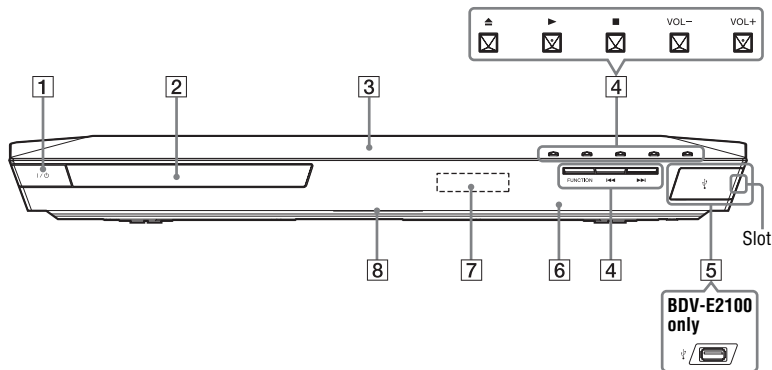

- 1** **I/⏻ (on/standby)**  
Turns on the unit, or sets it to standby mode.
- 2** **Disc tray (page 26)**
- 3** **N (N-Mark) (page 31)**  
Position the NFC-compatible device near this indication to activate the NFC function.
- 4** **Play operation buttons**  
**▲ (open/close)**  
**▶ a) b) (play)**  
**■ b) (stop)**  
**VOL +/-<sup>a)</sup>**  
**◀◀/▶▶ (previous/next)**  
**FUNCTION (page 24)**  
Selects the playback source.  
a) ▶ and VOL + buttons have a tactile dot. Use the tactile dot as a reference when operating the unit.  
b) Hold down ▶ on the unit for more than 2 seconds, the built-in sound demonstration will be played back on the system. Press ■ to stop the demonstration.

### Note

During the demonstration, the volume level may be higher than the volume level you have set.

- 5** **USB port (page 28)**  
(BDV-E6100/BDV-E4100/BDV-E3100 only) Place your fingernail in the slot to open the cover.
- 6** **Remote control sensor**
- 7** **Front panel display**
- 8** **LED indicator**  
White: Lights up when the unit is turned on.  
Blue (for *Bluetooth* status):  
– System is ready for pairing: Flashes quickly  
– During pairing: Flashes quickly  
– During connection: Flashes  
– Connection is established: Lights up

## Indicators in the front panel display

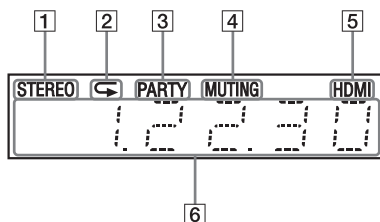

- 1 Lights up when stereo sound is received. (Radio only)
- 2 Lights up when repeat play is activated.
- 3 Lights up when the system is playing via the PARTY STREAMING function.
- 4 Lights up when muting is on.
- 5 Lights up when the HDMI (OUT) jack is correctly connected to an HDCP (High-bandwidth Digital Content Protection) compliant equipment with HDMI input.

- 6 Displays the system's status, such as radio frequency, etc.

When you press DISPLAY, the stream information/decoding status is displayed when the function is set to "TV".

The stream information/decoding status may not appear depending on the stream or item being decoded.

### Note

When the [Main Unit illumination] is set to [Auto] in [System Settings], the front panel display lights off if you do not operate the unit for about 10 seconds.

## Rear panel

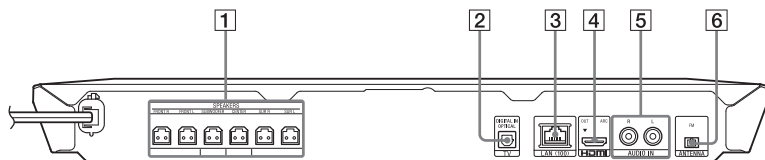

- 1 SPEAKERS jacks (page 18)
- 2 TV (DIGITAL IN OPTICAL) jack (page 19)
- 3 LAN (100) terminal (page 21)
- 4 HDMI (OUT) jack (page 19)
- 5 AUDIO IN (L/R) jacks (page 20)
- 6 ANTENNA (FM) terminal (page 21)

## Remote control

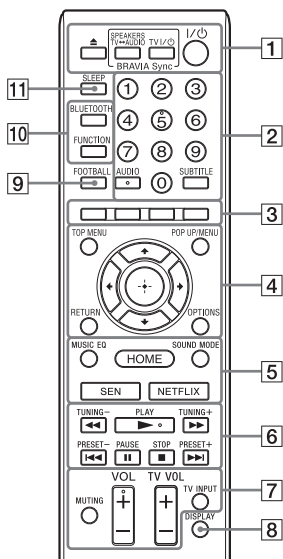

Number 5, AUDIO, VOL +, and ► buttons have a tactile dot. Use the tactile dot as a reference when operating the remote control.

- **TV** : For TV operations (For details, see “Controlling Your TV with the Supplied Remote Control” (page 42).)

### The system automatically returns to standby mode

If any button on the unit or remote control is not pressed within 30 minutes, the system automatically returns to standby mode.

#### 1 **▲ (open/close)**

Opens or closes the disc tray.

#### **SPEAKERS TV ↔ AUDIO**

Selects whether TV sound is output from the system’s speakers or the TV’s speaker(s). This function works only when you set [Control for HDMI] to [On] (page 50).

#### **TV I/O (on/standby) (page 43)**



Turns on the TV or sets it to standby mode.

#### **I/O (on/standby) (pages 23, 39)**

Turns on the system or sets it to standby mode.

#### 2 **Number buttons (pages 39, 43)**

Enters the title/chapter numbers, preset station number, etc.

#### **AUDIO (page 37)**

Selects the audio format/track.

#### **SUBTITLE**

Selects the subtitle language when multilingual subtitles are recorded on a BD-ROM/DVD VIDEO.

#### 3 **Color buttons**

Short cut keys for selecting items on some BD menus (can also be used for Java interactive operations on BDs).

#### 4 **TOP MENU**

Opens or closes the BD’s or DVD’s Top Menu.

#### **POP UP/MENU**

Opens or closes the BD-ROM’s Pop-up Menu, or the DVD’s menu.

#### **OPTIONS (pages 25, 35, 44)**

Displays the options menu on the TV screen or in the front panel display. (The location differs depending on the selected function.)

#### **RETURN**

Returns to the previous display.



Moves the highlight to a displayed item.

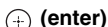

Enters the selected item.

## 5 MUSIC EQ

Selects the pre-programmed equalizer when listening to music.

### HOME (pages 23, 40, 45)

Enters or exits the system's home menu.

### SOUND MODE (page 24)

Selects the sound mode.

### SEN

Accesses the "Sony Entertainment Network™" online service.

### NETFLIX

Accesses the "NETFLIX" online service.

## 6 Playback operation buttons

See "Playback" (page 26).

### ◀◀/▶▶ (fast/slow/freeze frame)

Fast reverse/fast forward during playback. Each time you press the button, the search speed changes.

Activates slow-motion play when pressed for more than one second in pause mode.

Plays one frame at a time when pressed in pause mode.

#### Note

During Blu-ray 3D Disc playback, slow-motion reverse play and single-frame reverse play are not available.

### ◀◀/▶▶ (previous/next)

Selects the previous/next chapter, track, or file.

## ▶ PLAY

Starts or re-starts playback (resume play).

Activates One-Touch Play (page 40) when the system is on and set to the "BD/DVD" function.

## ■ PAUSE

Pauses or re-starts playback.

## ■ STOP

Stops playback and remembers the stop point (resume point). The resume point for a title/track is the last point you played or the last photo for a photo folder.

Stops the built-in sound demonstration.

## Radio operation buttons

See "Tuner" (page 38).

### TUNING +/-

### PRESET +/-

## 7 MUTING

Turns off the sound temporarily.

### VOL +/-

Adjusts the volume.

### TV VOL +/-

Adjusts the TV volume.

### TV INPUT

Switches the TV's input source between the TV and other input sources.

## 8 DISPLAY (pages 27, 32, 39, 44)

Displays playback and web browsing information on the TV screen.

Displays the preset radio station, frequency, etc., in the front panel display.

## 9 FOOTBALL

Produces optimized sound for watching football match broadcasting.



**10 BLUETOOTH**

Selects the “BT” function.

When the blue LED indicator lights off during “BT” function, press to start pairing or connect to paired *Bluetooth* device.

**FUNCTION (page 24)**

Selects the playback source.

**11 SLEEP (page 42)**

Sets the sleep timer.

**Getting Started****Step 1: Installing the Speakers**

Install the speakers by referring to the illustration below.

- (A) Front left speaker (L)
- (B) Front right speaker (R)
- (C) Center speaker
- (D) Surround left speaker (L)
- (E) Surround right speaker (R)
- (F) Subwoofer
- (G) TV

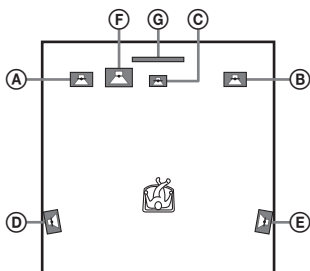
**Installing the surround speakers in rear position (Speaker layout: [Standard])**

## Installing all speakers in front position (Speaker layout: [All Front])

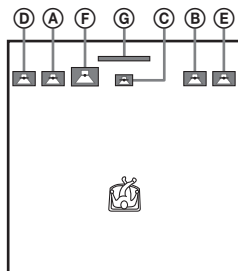

### Note

- Be sure to select the speakers layout setting (page 41) according to your speakers placement.
- Use caution when placing the speakers and/or speaker stands attached to the speakers on a specially treated (waxed, oiled, polished, etc.) floor, as staining or discoloration may result.
- Do not lean or hang on a speaker, as it may fall down.

### Tip

You can install the speakers on a wall. For details, refer to the supplied "Speaker Installation Guide".

## Step 2: Connecting the System

Do not connect the AC power cord (mains lead) of the unit to a wall outlet (mains) until all the other connections are made. (BDV-E6100/BDV-E4100 only) To assemble the speakers, refer to the supplied "Speaker Installation Guide".

### Note

When you connect other equipment with a volume control, turn down the volume of the equipment to a level where sound is not distorted.

## Connecting the speakers

Connect the speaker cords to match the color of the SPEAKERS jacks of the unit. When connecting to the unit, insert the connector until it clicks.

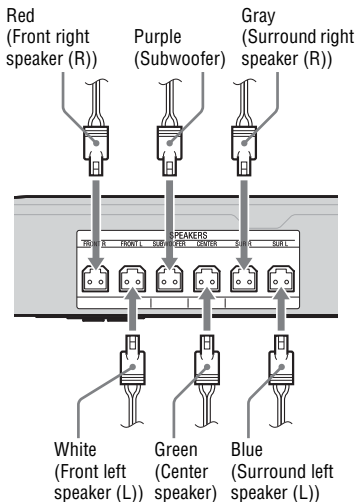

## Connecting the TV

Select one of the following connection methods according to the input jacks on your TV.

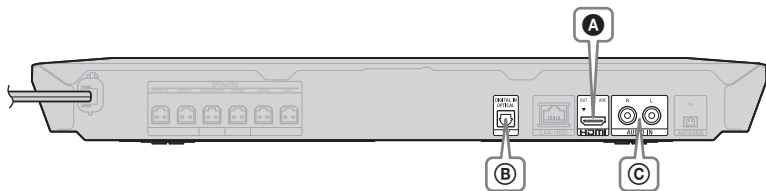

### Video connection

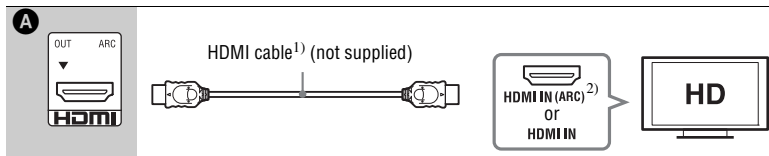

<sup>1)</sup> High Speed HDMI cable

<sup>2)</sup> The **Audio Return Channel (ARC) function** enables the TV to output sound through the system with an HDMI connection, without performing the (B) or (C) connection below. To set the ARC function on this system, see [Audio Return Channel] (page 50). To check the compatibility of your TV's ARC function, refer to the operating instructions supplied with your TV.

### Audio connections

If your TV's HDMI jack is not compatible with the ARC function, make an appropriate audio connection (B) or (C) for listening to TV sound via the system's speakers.

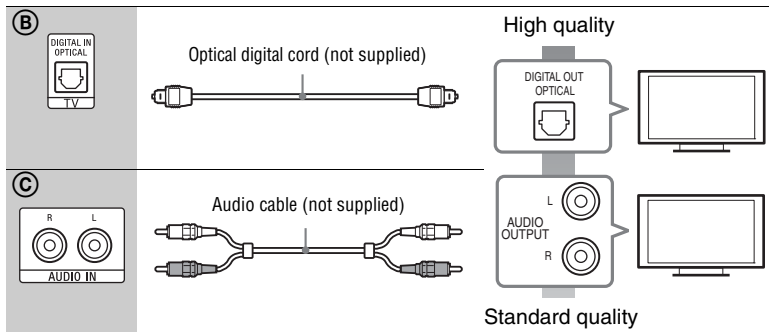

#### Note

To enjoy TV sound, select "TV" function for connection (B) or "AUDIO" function for connection (C).

## Connecting the other equipment

### If your TV is compatible with Audio Return Channel (ARC) function

Connect audio and video jacks of your equipment to the TV. The equipment sound can be output through the TV to the system by just making the HDMI connection **A** in “Connecting the TV” (page 19).

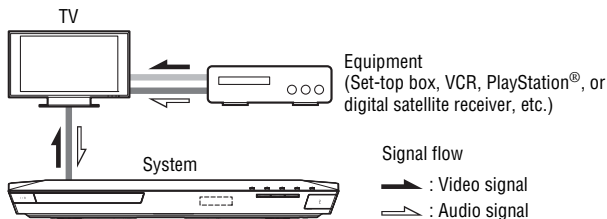

### If your TV is not compatible with Audio Return Channel (ARC) function

To enjoy the equipment sound via this system, make an appropriate audio connection (**A** or **B**).

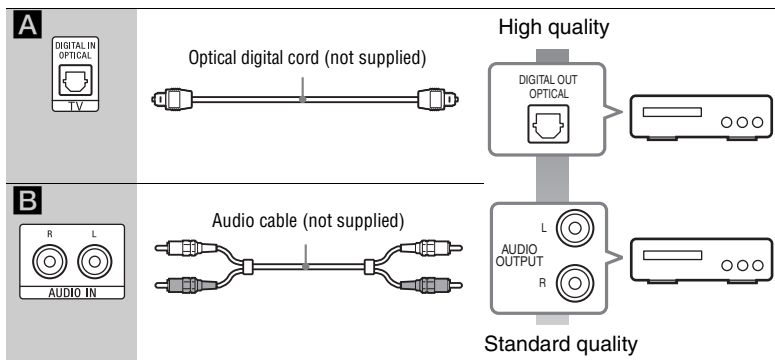

#### Note

- If you make either connection above, set [Control for HDMI] in [HDMI Settings] of [System Settings] to [Off] (page 50).
- You can enjoy equipment sound by selecting “TV” function for connection **A** or “AUDIO” function for connection **B**.

## Connecting the antenna (aerial)

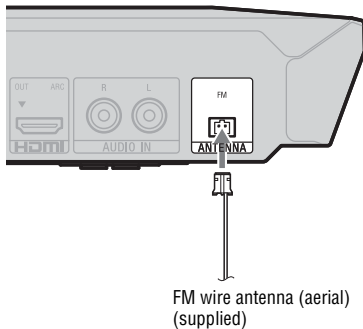

### Note

- Be sure to fully extend the FM wire antenna (aerial).
- After connecting the FM wire antenna (aerial), keep it as horizontal as possible.

## Step 3: Preparing for Network Connection

### Tip

To connect the system to your network, perform [Easy Network Settings]. For details, see “Step 4: Performing the Easy Setup” (page 23).

Select the method based on your LAN (Local Area Network) environment.

- If you use a wireless LAN  
The system has built-in Wi-Fi, and you can connect the system to the network by making the network settings.
- If you use other than a wireless LAN  
Use a LAN cable to connect to the LAN (100) terminal on the unit.

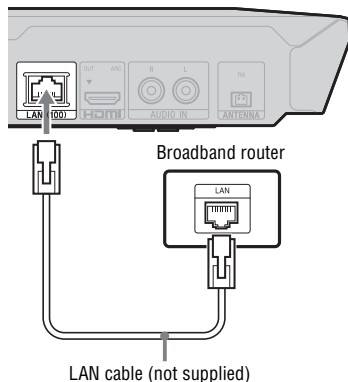

### Tip

A shielded interface cable (LAN cable), straight or crossover, is recommended.

## Before performing the network settings

When your wireless LAN router (access point) is Wi-Fi Protected Setup (WPS)-compatible, you can easily set the network settings with the WPS button.

If not, check the following information in advance, and record it in the space provided below.

- The network name (SSID\*) that identifies your network\*\*.
- 
- If security is set on your wireless network, the security key (WEP key, WPA key)\*\*.
- 

\* SSID (Service Set Identifier) is a name that identifies a particular wireless network.

\*\* You need to check the settings of your wireless LAN router to get the information about SSID and security key. For details:

- visit the following website:  
<http://www.sony.com/blurayhtsupport/>
- refer to the operating instructions supplied with the wireless LAN router
- consult the manufacturer of the wireless LAN router

## About wireless LAN security

Since communication via the wireless LAN function is established by radio waves, the wireless signal may be susceptible to interception. To protect wireless communication, this system supports various security functions. Be sure to correctly configure the security settings in accordance with your network environment.

### ■ No Security

Although you can easily make settings, anyone can intercept wireless communication or intrude into your wireless network, even without any sophisticated tools. Keep in mind that there is a risk of unauthorized access or interception of data.

### ■ WEP

WEP applies security to communications to prevent outsiders from intercepting communications or intruding into your wireless network. WEP is a legacy security technology that enables older devices which do not support TKIP/AES to be connected.

### ■ WPA-PSK (TKIP), WPA2-PSK (TKIP)

TKIP is a security technology developed in response to the deficiencies of WEP. TKIP assures a higher security level than WEP.

### ■ WPA-PSK (AES), WPA2-PSK (AES)

AES is a security technology that uses an advanced security method distinct from WEP and TKIP. AES assures a higher security level than WEP or TKIP.

## Step 4: Performing the Easy Setup

### Before performing Step 4

Make sure all connections are secure, and then connect the AC power cord (mains lead).

Follow the Steps below to make the basic adjustments and network settings for the system.

Displayed items vary depending on the area.

- 1 Insert two R6 (size AA) batteries (supplied) by matching the  $\oplus$  and  $\ominus$  ends on the batteries to the markings inside the compartment.

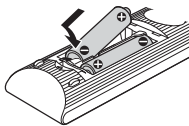

- 2 Turn on the TV.
- 3 Press I/⏻.
- 4 Switch the input selector on your TV so that the signal from the system appears on the TV screen.

The [Easy Initial Settings] for OSD language selection appears.

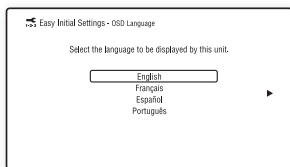

- 5 Perform [Easy Initial Settings]. Follow the on-screen instructions to make the basic settings using  $\leftarrow/\rightarrow$  and  $\oplus$ .

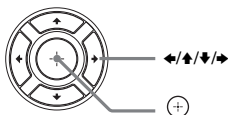

- 6 After completing the [Easy Initial Settings], press  $\leftarrow/\rightarrow$  to select [Easy Network Settings], then press  $\oplus$ .

The [Easy Network Settings] display appears.

- 7 Follow the on-screen instructions to make the network settings using  $\leftarrow/\rightarrow$  and  $\oplus$ .

If the system cannot connect to the network, see “Network connection” (page 59) or “Wireless LAN connection” (page 59).

### To recall the [Easy Network Settings] display

- 1 Press HOME.  
The home menu appears on the TV screen.
- 2 Press  $\leftarrow/\rightarrow$  to select  [Setup].
- 3 Press  $\uparrow/\downarrow$  to select [Easy Network Settings], then press  $\oplus$ .

## Step 5: Selecting the Playback Source

Press **FUNCTION** repeatedly until the function you want appears in the front panel display.

When you press **FUNCTION** once, the current function appears in the front panel display, then each time you press **FUNCTION**, the function changes cyclically as follows.

“BD/DVD” → “USB” → “FM” → “TV” → “BT” → “AUDIO”

---

### Function and playback source

#### “BD/DVD”

Disc or network device to be played by the system

#### “USB”

USB device that is connected to the  (USB) port (page 13)

#### “FM”

FM radio (page 38)

#### “TV”

Equipment (TV, etc.) that is connected to the TV (DIGITAL IN OPTICAL) jack, or a TV compatible with the Audio Return Channel function that is connected to the HDMI (OUT) jack (page 19)



#### “BT”

Audio contents of a *Bluetooth* device

#### “AUDIO”

Equipment that is connected to the AUDIO IN (L/R) jacks (page 20)

### Tip

- Some functions may be changed via the TV screen by pressing **FUNCTION**, , and .
- You can also press **BLUETOOTH** on the remote control to select “BT” function.

## Step 6: Enjoying Surround Sound

After performing the previous Steps and starting playback, you can easily enjoy pre-programmed sound modes that are tailored to different kinds of sound sources. They bring the exciting and powerful sound of movie theaters into your home.

### Selecting the sound mode

Press **SOUND MODE** repeatedly during playback until the mode you want appears in the front panel display or on the TV screen.

#### Auto

The system automatically selects [Movie] or [Music] to produce the sound effect depending on the disc or sound stream.

- 2-channel source: The system simulates surround sound from 2-channel sources and outputs sound from the 5.1 channel speakers.
- Multi-channel source: The system outputs sound from the speakers as it was recorded.

#### Movie

The system provides the optimized sound for watching movies.

#### Music

The system provides the optimized sound for listening to music.

#### Digital Music Enhancer [Digital Music]

The system reproduces an enhanced sound for compressed audio.

#### Night

Suitable for watching movies at night by reducing loud sounds while maintaining clear dialog.

#### Demo Sound

The system provides ear-catching sound, suitable for demonstration.



## To select the sound mode from the option menu

- 1 Press **OPTIONS** and **▲/▼** to select [Sound Mode], then press **⊕**.
- 2 Press **▲/▼** to select the sound mode, then press **⊕**.

## To select the pre-programmed music equalizer

Press **MUSIC EQ** repeatedly during playback.

You can select the sound to suit your preference.

Each time you press the button, the setting changes cyclically as follows.

[Standard] → [Rock] → [Hiphop] → [Electronica]

You can also select the music equalizer by using the option menu in [Music] sound mode.

### Note

The sound mode can be selected only when [Sound Effect] is set to [Sound Mode On] (page 48). When [Sound Effect] is set to other than [Sound Mode On], the sound mode setting does not apply.

### Tip

To enjoy 2-channel source such as a CD in multi-channel output, we recommend you to select [Auto].

## Selecting the football mode

### Press **FOOTBALL** during playback.

[Football] appears on the TV screen.

You can experience a feeling of presence in the stadium when watching a football match broadcasting.

To turn off the football mode, press **FOOTBALL** again to select [Football Off].

The sound mode is changed to the last selected sound mode.

### Note

- Depending on the source, the football mode may not work well.
- The football mode will be turned off when you turn off the system.

### Tip

You can also select the football mode from the option menu.

### Playing a Disc

For playable discs, see “Playable Discs” (page 60).

- 1 Switch the input selector on your TV so that the signal from the system appears on your TV screen.
- 2 Press  $\triangle$ , and place a disc on the disc tray.

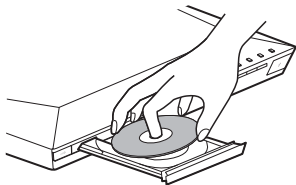

- 3 Press  $\triangle$  to close the disc tray. Playback starts.  
If playback does not start automatically, select  $\bullet$  in the  $\text{[Video]}$ ,  $\text{[Music]}$ , or  $\text{[Photo]}$  category, and press  $\oplus$ .

### Enjoying BONUSVIEW/ BD-LIVE

Some BD-ROMs with “BD-LIVE Logo\*\*” have bonus content and other data that can be downloaded for enjoyment.

\* BD-LIVE™

- 1 Connect the USB device to the  $\text{[USB]}$  port (page 28).  
For local storage, use a 1 GB or larger USB memory.
- 2 Prepare for BD-LIVE (BD-LIVE only).
  - Connect the system to a network (page 21).
  - Set [BD Internet Connection] to [Allow] (page 49).
- 3 Insert a BD-ROM with BONUSVIEW/BD-LIVE.  
The operation method differs depending on the disc. Refer to the operating instructions of the disc.

#### Tip

To delete data in the USB memory, select [Delete BD Data] in  $\text{[Video]}$ , and press  $\ominus$ . All data stored in the buda folder will be deleted.

## Enjoying Blu-ray 3D

You can enjoy Blu-ray 3D Discs with the 3D logo\*.



### 1 Prepare for Blu-ray 3D Disc playback.

- Connect the system to your 3D-compatible TV using a High Speed HDMI cable (page 19).
- Set [3D Output Setting] and [TV Screen Size Setting for 3D] in [Screen Settings] (page 46).

### 2 Insert a Blu-ray 3D Disc.

The operation method differs depending on the disc. Refer to the operating instructions supplied with the disc.

#### Tip

Refer also to the operating instructions of your 3D-compatible TV.

## Displaying the playback information

You can check the playback information, etc., by pressing DISPLAY. The displayed information differs depending on the disc type and system status.

Example: when playing a BD-ROM

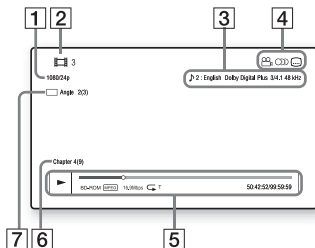

- 1 Output resolution/Video frequency
- 2 Title number or name
- 3 The currently selected audio setting
- 4 Available functions (angle, audio, subtitle)
- 5 Playback information  
Displays play mode, playing status bar, disc type, video codec, bit rate, repeat type, elapsed time, total playing time
- 6 Chapter number
- 7 The currently selected angle

## Playing from a USB Device

You can play video/music/photo files on a connected USB device.

For playable types of files, see “Playable Types of Files” (page 61).

### 1 Connect the USB device to the USB port.

Refer to the operating instructions of the USB device before connecting.

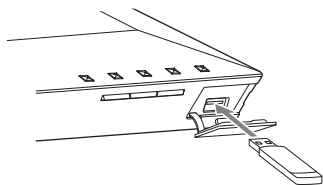

### 2 Press HOME.

The home menu appears on the TV screen.

### 3 Press $\leftarrow/\rightarrow$ to select [Video], [Music], or [Photo].

### 4 Press $\uparrow/\downarrow$ to select [USB device], then press .

#### Note

Do not remove the USB device during operation. To avoid data corruption or damage to the USB device, turn the system off before connecting or removing the USB device.

## Enjoying music from a Bluetooth device

### About the Bluetooth wireless technology

*Bluetooth* wireless technology is a short-range wireless technology that enables wireless data communication between digital devices. *Bluetooth* wireless technology operates within a range of about 10 meters (33 feet).

You do not need wires to get connected as you do with a USB connection, and you do not need to place the devices face to face as you do with wireless infrared technology. *Bluetooth* wireless technology is a global standard supported by thousands of companies. These companies produce products that meet the global standard.

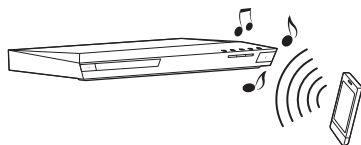

### Supported Bluetooth version and profiles

Profile refers to a standard set of capabilities for various *Bluetooth* product capabilities. This system supports the following *Bluetooth* version and profiles. Supported *Bluetooth* version:

*Bluetooth* Specification version 3.0

Supported *Bluetooth* profiles:  
A2DP 1.2 (Advanced Audio Distribution Profile)



AVRCP 1.3 (Audio Video Remote Control Profile)

**Note**

- To be able to use the *Bluetooth* function, the *Bluetooth* device to be connected must support the same profile as this system. Even if the device supports the same profile, the functions may differ depending on the specifications of the *Bluetooth* device.
- The audio playback on this system may be delayed from that on the *Bluetooth* device because of the characteristics of the *Bluetooth* wireless technology.

## Pairing this system with a *Bluetooth* device

Pairing is an operation where *Bluetooth* devices register with each other beforehand. Once a pairing operation is performed, it does not need to be performed again.

- 1 Place the *Bluetooth* device within 1 meter (3.3 feet) from the unit.**
- 2 Press BLUETOOTH.**  
You can also select  [Bluetooth AUDIO] from  [Input] in home menu.
- 3 Set the *Bluetooth* device in pairing mode.**  
For details on setting the *Bluetooth* device in pairing mode, refer to the operating instructions supplied with the device.
- 4 Select "BLU-RAY HOME THEATRE SYSTEM" on the *Bluetooth* device display.**  
Perform this step within 5 minutes, otherwise pairing will be canceled.

**Note**

If passkey is required on the *Bluetooth* device, enter "0000". Passkey may be called "Passcode", "PIN code", "PIN number" or "Password".

- 5 Once pairing is completed, the device is automatically connected to the system.**

Device name appears on the TV screen.

**Note**

You can pair up to 9 *Bluetooth* devices. If the 10th *Bluetooth* device is paired, the least recently connected device will be replaced by the new one.

- 6 Start playback on the *Bluetooth* device.**
- 7 Adjust the volume.**

Adjust the volume of the *Bluetooth* device first, if the volume level is still too low, adjust the volume level on the unit.

## To cancel pairing operation

Press HOME or FUNCTION.

## Connecting to a *Bluetooth* device from this system

You can connect to a *Bluetooth* device from this unit.

Check the following before playing music:

- The *Bluetooth* function of the *Bluetooth* device is turned on.
- The pairing has been completed (page 29).

- 1 Press BLUETOOTH.**

**Note**

To connect to the most recent connected *Bluetooth* device, press . Then proceed to Step 5.

- 2 Press OPTIONS.**

- 3 Press **▲/▼** repeatedly to select [Device List], then press **+**.  
A list of paired *Bluetooth* devices appears.
- 4 Press **▲/▼** repeatedly to select the device you want, then press **+**.
- 5 Press **▶** to start playback.
- 6 **Adjust the volume.**  
Adjust the volume of the *Bluetooth* device first, if the volume level is still too low, adjust the volume level on the unit.

**Note**

Once the unit and the *Bluetooth* device are connected, you can control playback by pressing **▶**, **⏮**, **■**, **⏭** and **⏮▶▶▶**.

### To disconnect the *Bluetooth* device

Press HOME, FUNCTION or RETURN.

### To delete a paired *Bluetooth* device from the device list

- 1 Follow Steps 1 to 3 above.
- 2 Press **▲/▼** repeatedly to select the device, then press OPTIONS.
- 3 Press **▲/▼** repeatedly to select [Remove], then press **+**.
- 4 Follow the on-screen instructions to delete the device using **▲/▼/▶/◀** and **+**.

**Note**

While connected to a *Bluetooth* device, this system cannot be detected and a connection cannot be established from another *Bluetooth* device.

## Connecting to a smartphone by One-touch listening function (NFC)

By holding an NFC-compatible smartphone near to the **N** on the unit, the unit and smartphone proceed to complete pairing and the *Bluetooth* connection automatically.

### Compatible smartphones

Smartphones with a built-in NFC function (OS: Android 2.3.3 – 4.0.x, excluding Android 3.x)

### What is “NFC”?

NFC (Near Field Communication) is a technology enabling short-range wireless communication between various devices, such as mobile phones and IC tags. Thanks to the NFC function, data communication can be achieved easily just by holding the device near the **N** on the NFC-compatible devices.

### 1 Download and install the app “NFC Easy Connect”.

“NFC Easy Connect” is a free app for Android smartphones that can be obtained on Google Play. Search for the app using the keyword “NFC Easy Connect” on the site, or access the download site directly by reading the two-dimensional code below. Note that “NFC Easy Connect” is free but data communication fees when downloading are charged separately.

## Two-dimensional code\* for direct access

\* Use a two-dimensional code reader app.



### Note

The app may not be available in some countries/regions.

## 2 Start the “NFC Easy Connect” app on the smartphone.

Make sure that the application screen is displayed.

## 3 Hold the smartphone near to the on the unit until the smartphone vibrates.



Vibration cue is provided when the smartphone is recognized by the unit. After being recognized by the unit, follow the on-screen instructions displayed on the smartphone, and complete the procedure for *Bluetooth* connection.

When the *Bluetooth* connection is established, the blue LED indicator on the front panel stops flashing. The playback time appears in the front panel display.

### Note

- The system only can recognizes and connects to one NFC-compatible device at a time.
- Depending on your smartphone, you may need to turn on the NFC function on your smartphone in advance. For details, refer to the operating instructions of the smartphone.

### Tip

If pairing and the *Bluetooth* connection fail, do the following.

- Relaunch “NFC Easy Connect” and move the smartphone slowly over the .
- Remove the case from the smartphone if using a commercially available smartphone case.

## To listen to music

Start playback of an audio source on the smartphone. For details on playback operations, refer to the operating instructions of your smartphone.

### Tip

If the volume level is low, adjust the volume of the smartphone first. If the volume level is still too low, adjust the volume level on the unit.

## To stop playback

The playback will be stopped when you perform any of the following items:

- Hold the smartphone near to the  on the unit again.
- Stop the music player of the smartphone.
- Turn off the unit or the smartphone.
- Change the function.
- Disable the *Bluetooth* function on the smartphone.

# Playing via a Network

## Enjoying Sony Entertainment Network (SEN)

Sony Entertainment Network serves as a gateway delivering selected Internet content and a variety of on-demand entertainment straight to your unit.

### Tip

- Some Internet content requires registration via a PC before it can be played. For further details, visit the following website:  
<http://www.sony.com/blurayhtsupport/>
- Some Internet content may not be available in some countries/regions.

### 1 Prepare for Sony Entertainment Network.

Connect the system to a network (page 21).

### 2 Press SEN.

### 3 Press $\leftarrow/\uparrow/\downarrow/\rightarrow$ to select the Internet content and a variety of on-demand entertainment, then press $\oplus$ .

## Video streaming control panel

The control panel appears when a video file starts playing. The displayed items may differ depending on the Internet content provider.

To display again, press DISPLAY.

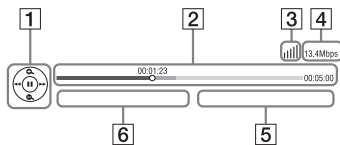

- 1 Control display**  
Press  $\leftarrow/\uparrow/\downarrow/\rightarrow$  or  $\oplus$  for playback operations.
- 2 Playing status bar**  
Status bar, cursor indicating the current position, playing time, duration of the video file
- 3 Network condition indicator**  
 Indicates signal strength for a wireless connection.  
 Indicates a wired connection.
- 4 Network transmission speed**
- 5 The next video file name**
- 6 The currently selected video file name**



## Playing files on a Home Network (DLNA)

You can play video/music/photo files on other DLNA-certified equipment by connecting them to your home network.

This unit can be used as a player and renderer.

- **Server:** Stores and shares digital media contents
- **Player:** Finds and plays digital media content from the DMS
- **Renderer:** Receives and plays files from the server, and can be operated by another equipment (controller)
- **Controller:** Operates the renderer equipment

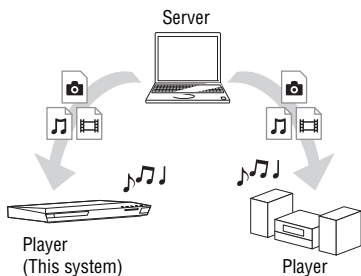

### Prepare for using the DLNA function.

- Connect the system to a network (page 21).
- Prepare other DLNA-certified equipment. For details, refer to the operating instructions of the equipment.

## To play files stored on a DLNA server via the system (DLNA Player)

Select the DLNA server icon from [Video], [Music], or [Photo] in the home menu, then select the file that you want to play.

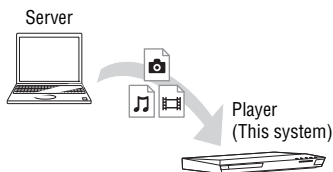

## To play remote files by operating the system (Renderer) via a DLNA controller

You can operate the system with a DLNA-certified controller (a mobile phone, etc), when playing files stored on a DLNA server.

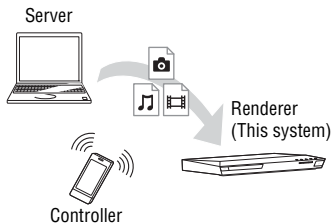

For details on operation, refer to the operating instructions of the DLNA controller.

### Note

Do not operate the system with the supplied remote control and a DLNA controller at the same time.

### Tip

The system is compatible with the “Play To” function of Windows Media® Player 12 that comes standard with Windows 7.

## Playing the same music in different rooms (PARTY STREAMING)

You can play the same music at the same time on all Sony equipment which are compatible with the PARTY STREAMING function and connected to your home network.

Contents in [Music] and the “FM”, “BT” and “AUDIO” functions can be used with the PARTY STREAMING function.

There are two kinds of PARTY STREAMING-compatible equipment.

- PARTY host: Plays and sends music.
- PARTY guest: Plays music that is received from PARTY host.

This unit can be used as a PARTY host or PARTY guest.

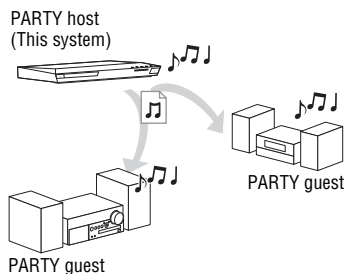

### Prepare for PARTY STREAMING.

- Connect the system to a network (page 21).
- Connect equipment which is compatible with the PARTY STREAMING function.

### To use the system as the PARTY host

Select a track in [Music], a radio station in [Radio], [AUDIO] or [Bluetooth AUDIO] in [Input], press OPTIONS. Then select [Start PARTY] to start.

To close, press OPTIONS, then select [Close PARTY].

#### Note

If content that is not compatible with the PARTY STREAMING function is played, the system closes PARTY automatically.

### To use the system as a PARTY guest

Select [PARTY] in [Music], then select the PARTY host device icon.

To leave the PARTY, press OPTIONS, then select [Leave PARTY].

To close the PARTY, press OPTIONS, then select [Close PARTY].

#### Note



The sale and product lineup of products that are compatible with the PARTY STREAMING function differ depending on the area.



## Searching for video/music information

You can acquire content information using Gracenote technology and search for related information.

- 1** Connect the system to a network (page 21).
- 2** Insert a disc with content about which you want to search.

You can perform a video search from a BD-ROM or DVD-ROM, and a music search from a CD-DA (music CD).

**3** Press **↔** to select  [Video] or  [Music].

**4** Press **↕** to select  [Video Search] or  [Music Search].

The content information (such as title, cast, track, or artist), [Playback History] and [Search History] are displayed.

- [Playback History]  
Displays a list of previously played BD-ROM/DVD-ROM/CD-DA (music CD) titles. Select a title to acquire content information.
- [Search History]  
Displays a list of previous searches performed via the [Video Search] or [Music Search] function.

## To search for further related information

Select an item in the lists, then select the service for searches.

## Using the TV SideView

TV SideView is a free mobile application for the remote device (smartphone, etc). By using the TV SideView with this system, you can easily enjoy the system by the operation on your remote device.

You can launch a service or application directly from the remote device and view the disc information during the disc playback. The TV SideView also can be used as a remote control and software keyboard.

Before you use the TV SideView device with this system for the first time, be sure to register the TV SideView device.

Follow the on-screen instructions on the TV SideView device for registration.

### Note

The registration will be possible only when home menu appears on the TV screen.

## Available Options

Various settings and playback operations are available by pressing **OPTIONS**. The available items differ depending on the situation.

### Common options

---

#### [Sound Mode]

Changes the sound mode setting (page 24).

---

#### [Football]

Turns on or off the football mode (page 25).

---

#### [Repeat Setting]

Sets repeat playback.

---

#### [3D Menu]

[Simulated 3D]: Adjusts the simulated 3D effect.

[3D Depth Adjustment]: Adjusts the depth of 3D images.

[2D Playback]: Sets playback to 2D image.

---

#### [Play/Stop]

Starts or stops playback.

---

#### [Play from beginning]

Plays the item from the beginning.

---

#### [Start PARTY]

Starts a party with the selected source.

This item may not appear depending on the source.

---

#### [Leave PARTY]

Leaves a party which the system is participating in. The PARTY STREAMING function continues among other participating equipment.

---



#### [Close PARTY]

For PARTY host: Closes a party.

For PARTY guest: Closes a party which the system is participating in. The PARTY STREAMING function ends for all other participating equipment.

---

#### [Change Category]

Switches among the  [Video],  [Music] and  [Photo] category in "BD/DVD" (for disc only) or "USB" function. This item only available when the display list is available for the category.

---

## **[Video] only**

---

### **[A/V SYNC]**

Adjusts the time gap between picture and sound (page 37).

---

### **[3D Output Setting]**

Sets whether or not to output 3D video automatically.

---

### **[Video Settings]**

- [Picture Quality Mode]: Selects the picture settings for different lighting environments.
- [BNR]: Reduces the mosaic-like block noise in the picture.
- [MNR]: Reduces minor noise around the picture outlines (mosquito noise).

---

### **[Pause]**

Pauses playback.

---

### **[Top Menu]**

Displays the BD's or DVD's Top Menu.

---

### **[Menu/Popup Menu]**

Displays the BD-ROM's Pop-up Menu or DVD's menu.

---

### **[Title Search]**

Searches for a title on BD-ROMs/DVD VIDEOS and starts playback from the beginning.

---

### **[Chapter Search]**

Searches for a chapter and starts playback from the beginning.

---

### **[Audio]**

Selects the audio format/track.

---

### **[Subtitle]**

Selects the subtitle language when multilingual subtitles are recorded on BD-ROMs/DVD VIDEOS.

---

### **[Angle]**

Switches the viewing angles when multi-angles are recorded on BD-ROMs/DVD VIDEOS.

---

### **[IP Content Noise Reduction]**

Adjusts the video quality for Internet content.

---

### **[Video Search]**

Displays information on the BD-ROM/DVD-ROM based on Gracenote technology.

---

## **[Music] only**

---

### **[Add Slideshow BGM]**

Registers music files in the USB memory as slideshow background music (BGM).

---

### **[Music Search]**

Displays information on the audio CD (CD-DA) based on Gracenote technology.

---

## **[Photo] only**

---

### **[Slideshow]**

Starts a slideshow.

---

### **[Slideshow Speed]**

Changes the slideshow speed.

---

### **[Slideshow Effect]**

Sets the effect when playing a slideshow.

---

### **[Slideshow BGM]**

- [Off]: Turns off the function.
- [My Music from USB]: Sets the music files registered in [Add Slideshow BGM].
- [Play from Music CD]: Sets the tracks on CD-DAs (music CDs).

---

### **[Change Display]**

Switches between [Grid View] and [List View].

---

### **[Rotate Left]**

Rotates the photo counterclockwise by 90 degrees.

---

### **[Rotate Right]**

Rotates the photo clockwise by 90 degrees.

---

### **[View Image]**

Displays the selected picture.

---

## Adjusting the delay between the picture and sound

### (A/V SYNC)

When the sound does not match the pictures on the TV screen, you can adjust the delay between the picture and sound for each function separately.

The setting method differs depending on the function.

### When other than the “BT” or “TV” function is selected

#### 1 Press **OPTIONS**.

The option menu appears on the TV screen.

#### 2 Press **↑/↓** to select [A/V SYNC], then press **⊕**.

#### 3 Press **←/→** to adjust the delay, then press **⊕**.

You can adjust from 0 ms to 300 ms in 25 ms increments.

### When the “TV” function is selected

#### 1 Press **OPTIONS**.

“AV.SYNC” appears in the front panel display.

#### 2 Press **⊕** or **→**.

#### 3 Press **↑/↓** to adjust the delay, then press **⊕**.

You can adjust from 0 ms to 300 ms in 25 ms increments.

#### 4 Press **OPTIONS**.

The option menu in the front panel display turns off.

## Sound Adjustment

### Selecting the Audio Format, Multilingual Tracks, or Channel

When the system is playing a BD/DVD VIDEO recorded in multiple audio formats (PCM, Dolby Digital, MPEG audio, or DTS) or multilingual tracks, you can change the audio format or language. With a CD, you can select the sound from the right or left channel and listen to the sound of the selected channel through both the right and left speakers.

#### Press **AUDIO** repeatedly during playback to select the audio signal you want.

The audio information appears on the TV screen.

#### ■ **BD/DVD VIDEO**

Depending on the BD/DVD VIDEO, the option of language varies.

When 4 digits are displayed, they represent a language code. See “Language Code List” (page 66). When the same language is displayed two or more times, the BD/DVD VIDEO is recorded in multiple audio formats.

#### ■ **DVD-VR**

The types of sound tracks recorded on a disc are displayed.

Example:

- [♪ Stereo]
- [♪ Stereo (Audio1)]
- [♪ Stereo (Audio2)]
- [♪ Main]
- [♪ Sub]
- [♪ Main/Sub]

**Note**

[♪ Stereo (Audio1)] and [♪ Stereo (Audio2)] do not appear if only one audio stream is recorded on the disc.

**■ CD**

- [♪ Stereo]: The standard stereo sound.
- [♪ 1/L]: The sound of the left channel (monaural).
- [♪ 2/R]: The sound of the right channel (monaural).
- [♪ L+R]: The sound of both the left and right channels output from each individual speaker.

## Enjoying Multiplex Broadcast Sound

**(DUAL MONO)**

You can enjoy multiplex broadcast sound when the system receives or plays a Dolby Digital multiplex broadcast signal.

**Note**

To receive a Dolby Digital signal, you need to connect a TV or other equipment to the TV (DIGITAL IN OPTICAL) jack with a optical digital cord (pages 19, 20).

If your TV's HDMI IN jack is compatible with the Audio Return Channel function (pages 19, 50), you can receive a Dolby Digital signal via an HDMI cable.

Press **AUDIO** repeatedly until the signal you want appears in the front panel display.

- **“MAIN”**: Sound of the main language will be output.
- **“SUB”**: Sound of the sub language will be output.
- **“MN/SUB”**: Mixed sound of both the main and sub languages will be output.

## Tuner

### Listening to the Radio

- 1 Press FUNCTION repeatedly until “FM” appears in the front panel display.**
- 2 Select the radio station.**

**Automatic tuning**

Hold down TUNING +/- until the auto scanning starts.

[Auto Tuning] appears on the TV screen. Scanning stops when the system tunes in a station.

To cancel automatic tuning, press any buttons.

**Manual tuning**

Press TUNING +/- repeatedly.

- 3 Press VOL +/- repeatedly to adjust the volume.**

**If an FM program is noisy**

If an FM program is noisy, you can select monaural reception. There will be no stereo effect, but reception will improve.

- 1 Press OPTIONS.**  
The option menu appears on the TV screen.
- 2 Press  $\uparrow/\downarrow$  to select [FM Mode], then press  $\oplus$ .**
- 3 Press  $\uparrow/\downarrow$  to select [Monaural], then press  $\oplus$ .**
  - [Stereo]: Stereo reception.
  - [Monaural]: Monaural reception.

**Tip**

You can set [FM Mode] for each preset station separately.

## To turn off the radio

Press **I/O**.

### Presetting radio stations

You can preset up to 20 stations. Before tuning, make sure to turn down the volume to minimum.

- 1 Press FUNCTION repeatedly until "FM" appears in the front panel display.**
- 2 Hold down TUNING +/- until the auto scanning starts.**  
Scanning stops when the system tunes in a station.
- 3 Press OPTIONS.**  
The option menu appears on the TV screen.
- 4 Press  $\uparrow/\downarrow$  to select [Preset Memory], then press  $\oplus$ .**
- 5 Press  $\uparrow/\downarrow$  to select the preset number you want, then press  $\oplus$ .**
- 6 Repeat Steps 2 to 5 to store other stations.**

### To change a preset number

Select the preset number you want by pressing PRESET +/-, then perform the procedure from Step 3.

### Selecting a preset station

- 1 Press FUNCTION repeatedly until "FM" appears in the front panel display.**  
The last received station is tuned in.
- 2 Press PRESET +/- repeatedly to select the preset station.**

The preset number and frequency appear on the TV screen and front panel display.

Each time you press the button, the system tunes in one preset station.

#### Tip

- You can select the preset station number directly by pressing the number buttons.
- Each time you press DISPLAY, the display in the front panel display changes cyclically as follows:  
Frequency  $\rightarrow$  Preset number  $\rightarrow$  Decoding status\*  
\* Appears when [Sound Effect] is set to [Dolby Pro Logic], [DTS Neo:6 Cinema], or [DTS Neo:6 Music] (page 48).

## Other Operations

### Using the Control for HDMI Function for “BRAVIA” Sync

This function is available on TVs with the “BRAVIA” Sync function.

By connecting Sony equipment that is compatible with the Control for HDMI function via an HDMI cable, operation is simplified.

#### Note

To use the “BRAVIA” Sync function, be sure to turn on the system and all connected equipment after completed the HDMI connection.

### Control for HDMI - Easy Setting

You can set the system’s [Control for HDMI] function automatically by enabling the corresponding setting on the TV.

For details about the Control for HDMI function, see “[HDMI Settings]” (page 50)

### System Power Off

You can turn the system off in sync with the TV.

#### Note

The system does not turn off automatically while playing music or when “FM” function is selected.

### One-Touch Play

When you press  on the remote control, the system and TV turn on, and the TV’s input is switched to the HDMI input which the system is connected.

### System Audio Control

You can enjoy the sound from TV or other equipment by a simple operation.

You can use the System Audio Control function as follows:

- When the system is turned on, the sound of the TV or other equipment can be output from the speakers of the system.
- When sound from the TV or other equipment is output via the speakers of the system, you can switch the sound to output from the TV speakers by pressing **SPEAKERS TV**  **AUDIO**.
- When sound from the TV or other equipment is output via the speakers of the system, you can adjust the volume and turn off the sound of the system by operating the TV.

### Audio Return Channel

You can enjoy TV sound via the system by using just one HDMI cable. For details of the setting, see “[Audio Return Channel]” (page 50).

### Language Follow

When you change the language for the on-screen display of the TV, the system’s on-screen display language is also changed after turning off and on the system.

## Setting the Speakers

### [Speaker Settings]

To obtain optimum surround sound, set the speakers’ distance from your listening position. Then use the test tone to adjust the balance of the speakers.

#### 1 Press HOME.

The home menu appears on the TV screen.



**2** Press **↔** to select  [Setup].

**3** Press **↕** to select [Audio Settings], then press **+**.

**4** Press **↕** to select [Speaker Settings], then press **+**.

The [Select speaker layout.] display appears.

**5** Press **↕** to select setting according to your speakers placement, then press **+**.

- [Standard]: The surround speakers are installed in the rear position.
- [All Front]: All speakers are installed in the front position.

**Note**

The [Distance] and [Level] settings are reset to default settings each time you change the speaker layout setting.

**6** Press **↕** to select the item, then press **+**.

**7** Press **↕** to adjust the parameter.

**8** Press **↔** and **+** to confirm the settings.

Check the following settings.

■ [Distance]

Be sure to set the parameters of the distance from the listening position to the speakers. You can set the parameters from 0 to 23 feet (0.0 to 7.0 meters).

[Front Left/Right] 10 ft/3.0 m: Set the front speaker distance.

[Center] 10 ft/3.0 m: Set the center speaker distance.

[Surround Left/Right] 10 ft/3.0 m: Set the surround speaker distance.

[Subwoofer] 10 ft/3.0 m: Set the subwoofer distance.

**Tip**

You can change the unit of measurement (feet or meters) by pressing the color button (RED).

■ [Level]

You can adjust the sound level of the speakers. You can set the parameters from -6.0 dB to +6.0 dB. Be sure to set [Test Tone] to [On] for easy adjustment.

[Front Left/Right] 0.0 dB: Set the front speaker level.

[Center] 0.0 dB: Set the center speaker level.

[Surround Left/Right] 0.0 dB: Set the surround speaker level.

[Subwoofer] 0.0 dB: Set the subwoofer level.

■ [Test Tone]

The speakers will emit a test tone to adjust [Level].

[Off]: The test tone is not emitted from the speakers.

[On]: The test tone is emitted from each speaker in sequence while adjusting level.

When you select one of the [Speaker Settings] items, the test tone is emitted from each speaker in sequence.

Adjust the sound level as follows.

**1** Set [Test Tone] to [On].

**2** Press **↕** to select [Level], then press **+**.

**3** Press **↕** to select the speaker type you want, then press **+**.

**4** Press **↔** to select the left or right speaker, then press **↕** to adjust the level.

**5** Press **+**.

**6** Repeat Steps 3 to 5.

## 7 Press RETURN.

The system returns to the previous display.

## 8 Press $\blacktriangle/\blacktriangledown$ to select [Test Tone], then press $\oplus$ .

## 9 Press $\blacktriangle/\blacktriangledown$ to select [Off], then press $\oplus$ .

### Note

The test tone signals are not output from the HDMI (OUT) jack.

### Tip

To adjust the volume of all the speakers at one time, press VOL +/-.

---

## Using the Sleep Timer

You can set the system to turn off at a preset time, so you can fall asleep listening to music. The time can be preset in intervals of 10 minutes.

### Press SLEEP.

Each time you press SLEEP, the minutes display (the remaining time) in the front panel display changes by 10 minutes.

When you set the sleep timer, the remaining time appears every 5 minutes. When the remaining time is less than 2 minutes, "SLEEP" flashes in the front panel display.

### To check the remaining time

Press SLEEP once.

### To change the remaining time

Press SLEEP repeatedly.

---

## Deactivating the Buttons on the Unit

### (Child Lock)

You can deactivate the buttons on the unit (except for  $\mathbb{I}/\mathbb{C}$ ) for preventing misoperation, such as child mischief.

### Hold down $\blacksquare$ on the unit for more than 5 seconds.

"LOCKED" appears in the front panel display.

The child lock function is activated and the buttons on the unit are locked. (You can operate the system by using the remote control.)

To cancel, hold down  $\blacksquare$  for more than 5 seconds until "UNLOCK" appears in the front panel display.

### Note

If you operate the buttons on the unit while the child lock function is on, "LOCKED" flashes in the front panel display.

---

## Controlling Your TV with the Supplied Remote Control

By adjusting the remote control signal, you can control your TV with the supplied remote control.

### Note

When you replace the batteries of the remote control, the code number may reset to the default (SONY) setting. Set the appropriate code number again.

## Preparing the remote control for controlling the TV

While holding down TV I/⏻, press number buttons to enter your TV's manufacturer's code (see the table). Then release TV I/⏻.

Manufacturer	Code number
SONY	01 (default)
LG	02
PANASONIC	05
SAMSUNG	02, 06
SHARP	03
TOSHIBA	04
VIZIO	07

If the setting is unsuccessful, the currently registered code is not changed. Re-enter the code number.

If more than one code number is listed, try entering them one at a time until you find the code that works with your TV.

## Saving Power in Standby Mode

Check that you have made the following settings:

- [Control for HDMI] in [HDMI Settings] is set to [Off] (page 50).
- [Quick Start Mode] is set to [Off] (page 50).
- [Remote Start] in [Network Settings] is set to [Off] (page 51).

## Browsing Websites

### 1 Prepare for Internet browsing.

Connect the system to a network (page 21).

### 2 Press HOME.

The home menu appears on the TV screen.

### 3 Press ⏪/⏩ to select [Network].

### 4 Press ⏪/⏩ to select [Internet Browser], then press .

The [Internet Browser] display appears.

#### Note

Some websites may not display correctly, or not function.

### To enter a URL

Select [URL entry] from the options menu. Enter the URL using the software keyboard, then select [Enter].

### To set the default start page

While the page you want to set is displayed, select [Set as start page] from the options menu.

### To return to the previous page

Select [Previous page] from the options menu.

When the previous page does not appear even if you select [Previous page], select [Window List] from the options menu and select the page you want to return to from the list.

### To quit Internet Browser

Press HOME.

## Internet Browser display

You can check website information by pressing DISPLAY. The display information differs depending on the website and page status.

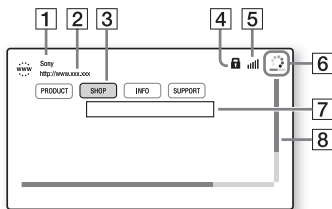

- 1** Page title
- 2** Page address
- 3** Cursor  
Move by pressing  $\leftarrow/\uparrow/\downarrow/\rightarrow$ . Place the cursor on the link you want to view, then press  $\odot$ . The linked website is displayed.
- 4** SSL icon  
Appears when the linked URL is secured.
- 5** Signal strength indicator  
Appears when the system is connected to a wireless network.
- 6** Progress bar/Loading icon  
Appears when the page is being read, or during file download/transfer.
- 7** Text input field  
Press  $\odot$ , then choose [Input] from the options menu to open the software keyboard.
- 8** Scroll bar  
Press  $\leftarrow/\uparrow/\downarrow/\rightarrow$  to move the page display left, up, down, or right.

## Available options

Various settings and operations are available by pressing OPTIONS. The available items differ depending on the situation.

---

### [Browser Setup]

Displays the Internet Browser settings.

- [Zoom]: Increases or decreases the size of the displayed contents.
- [JavaScript Setup]: Sets whether to enable or disable JavaScript.
- [Cookie Setup]: Sets whether or not to accept browser cookies.
- [SSL Alarm Display]: Sets whether to enable or disable SSL.

---

### [Window List]

Displays a list of all current opened websites. Allows you to return to a previous displayed website by selecting the window.

---

### [Bookmark List]

Displays the bookmark list.

---

### [URL entry]

Allows you to enter a URL when the software keyboard is displayed.

---

### [Previous page]

Moves to a previous displayed page.

---

### [Next page]

Moves to the previous displayed next page.

---

### [Cancel loading]

Stops loading a page.

---

### [Reload]

Reloads the same page.

---

### [Add to Bookmark]

Adds the current displayed website to the bookmark list.

---

### [Set as start page]

Sets the current displayed website as the default start page.

---

### [Open in new window]

Opens a link in a new window.

---

### [Character encoding]

Sets the character encoding system.

---

**[Display certificate]**

Displays server certificates sent from pages that support SSL.

**[Input]**

Displays the software keyboard to enter characters while browsing a website.

**[Break]**

Moves the cursor to the next line in the text input field.

**[Delete]**

Erases one character on the left side of the cursor during text input.

## Settings and Adjustments

### Using the Setup Display

You can make various adjustments to items such as picture and sound.

The default settings are underlined.

**Note**





Playback settings stored in the disc take priority over the Setup Display settings. Therefore, some of the functions may not be performed.





#### 1 Press HOME.

The home menu appears on the TV screen.

#### 2 Press to select [Setup].

#### 3 Press to select the setup category icon, then press .

Icon	Explanation
	<b>[Network Update]</b> (page 46) Updates the software of the system.
	<b>[Screen Settings]</b> (page 46) Makes the screen settings according to the type of TV.
	<b>[Audio Settings]</b> (page 48) Makes the audio settings according to the type of connecting jacks.
	<b>[BD/DVD Viewing Settings]</b> (page 49) Makes detailed settings for BD/DVD playback.

Icon	Explanation
	<b>[Parental Control Settings] (page 49)</b> Makes detailed settings for the Parental Control function.
	<b>[System Settings] (page 50)</b> Makes the system-related settings.
	<b>[Network Settings] (page 51)</b> Makes detailed settings for Internet and network.
 1-2-3	<b>[Easy Network Settings] (page 52)</b> Runs [Easy Network Settings] to make the basic network settings.
	<b>[Resetting] (page 52)</b> Resets the system to the factory settings.

## [Network Update]

By updating your software to the latest version, you can take advantage of the newest functions.

For information about update functions, refer to the following website:  
<http://www.sony.com/blurayhtsupport/>

During a software update, “UPDATE” appears in the front panel display. After the update completes, the unit automatically turns off.

While the updating operation is in progress, do not turn on or off the unit, or operate the unit or TV. Wait for the software update to complete.

## [Screen Settings]

### ■ [3D Output Setting]

[Auto]: Normally select this.

[Off]: Select this to display all contents in 2D.

### ■ [TV Screen Size Setting for 3D]

Sets the screen size of your 3D-compatible TV.

### ■ [TV Type]

[16:9]: Select this when connecting to a wide-screen TV or a TV with a wide-mode function.

[4:3]: Select this when connecting to a 4:3 screen TV without a wide-mode function.

### ■ [Screen Format]

[Full]: Select this when connecting to a TV with a wide-mode function. Displays a 4:3 screen picture in 16:9 aspect ratio even on a wide-screen TV.

[Normal]: Changes the picture size to fit the screen size with the original picture aspect ratio.

---

**■ [DVD Aspect Ratio]**

[Letter Box]: Displays a wide picture with black bands on the top and bottom.



[Pan & Scan]: Displays a full-height picture on the entire screen, with trimmed sides.

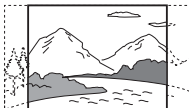

---

**■ [Cinema Conversion Mode]**

[Auto]: Normally select this. The unit automatically detects whether the material is video-based or film-based, and switches to the appropriate conversion method.

[Video]: The conversion method suited for video-based material will always be selected regardless of the material.

---

**■ [Output Video Resolution]**

[Auto]: Outputs video signal according to the resolution of the TV or connected equipment.

[Original Resolution]: Outputs video signal according to the resolution recorded on the disc. (When the resolution is lower than SD resolution, it is scaled up to SD resolution.)

[480i/576i]\*, [480p/576p]\*, [720p],

[1080i], [1080p]: Outputs video signal according to the selected resolution setting.

\* If the color system of your disc is NTSC, the video signals resolution can be converted to [480i] and [480p] only.

---

**■ [BD-ROM 24p Output]**

[Auto]: Outputs 24p video signals only when you connect a 1080/24p-compatible TV via an HDMI connection and the [Output Video Resolution] is set to [Auto] or [1080p].

[On]: Select this when your TV is compatible with 1080/24p video signals.

[Off]: Select this when your TV is not compatible with 1080/24p video signals.

---

**■ [DVD-ROM 24p Output]**

[Auto]: Outputs 24p video signals only when you connect a 1080/24p-compatible TV via an HDMI connection and the [Output Video Resolution] is set to [Auto] or [1080p].

[Off]: Select this when your TV is not compatible with 1080/24p video signals.

---

**■ [YCbCr/RGB (HDMI)]**

[Auto]: Automatically detects the type of external equipment, and switches to the matching color setting.

[YCbCr (4:2:2)]: Outputs YCbCr 4:2:2 video signals.

[YCbCr (4:4:4)]: Outputs YCbCr 4:4:4 video signals.

[RGB]: Select this when connecting to an equipment with an HDCP compliant DVI jack.

---

**■ [HDMI Deep Color Output]**

[Auto]: Normally select this.

[16bit], [12bit], [10bit]: Outputs 16bit/12bit/10bit video signals when the connected TV is compatible with Deep Color.

[Off]: Select this when the picture is unstable or colors appear unnatural.

---

### ■ [Pause Mode] (BD/DVD VIDEO/ DVD-R/DVD-RW only)

[Auto]: The picture, including subjects that move dynamically, is output with no jitter. Normally select this position.

[Frame]: The picture, including subjects that do not move dynamically, is output in high resolution.



## [Audio Settings]

---

### ■ [BD Audio MIX Setting]

[On]: Outputs the audio obtained by mixing the interactive audio and secondary audio to the primary audio.

[Off]: Outputs the primary audio only.

---

### ■ [Audio DRC]

You can compress the dynamic range of the sound track.

[Auto]: Performs playback at the dynamic range specified by the disc (BD-ROM only).

[On]: The system reproduces the sound track with the kind of dynamic range that the recording engineer intended.

[Off]: No compression of dynamic range.

---

### ■ [Attenuate - AUDIO]

Distortion may occur when you listen to an equipment connected to the AUDIO IN (L/R) jacks. You can prevent distortion by attenuating the input level on the unit.

[On]: Attenuates the input level. The output level will decrease at this setting.

[Off]: Normal input level.

---

### ■ [Audio Output]

You can select the output method where the audio signal is output.

[Speaker]: Outputs multi-channel sound from the system's speakers only.

[Speaker + HDMI]: Outputs multi-channel sound from the system's speakers and 2-channel linear PCM signals from the HDMI (OUT) jack.

[HDMI]: Outputs sound from the HDMI (OUT) jack only. Sound format depends on the connected equipment.

#### Note

- When [Control for HDMI] is set to [On] (page 50), [Audio Output] is set to [Speaker + HDMI] automatically and this setting cannot be changed.
- When [Audio Output] is set to [HDMI], the output signal format for the "TV" function is 2-channel linear PCM.

---

### ■ [Sound Effect]

You can turn on or off the system's sound effects (SOUND MODE setting (page 24)). For a 2-channel source, you can select [Dolby Pro Logic], [DTS Neo:6 Cinema], or [DTS Neo:6 Music] to simulate surround sound.

[Sound Mode On]: Enables the surround effect of the sound mode (page 24) and Football mode (page 25).

[Dolby Pro Logic]: The system simulates surround sound from 2-channel sources and outputs sound from all speakers (5.1 channel) (Dolby Pro Logic decoding).  
[DTS Neo:6 Cinema]/[DTS Neo:6 Music]: The system simulates surround sound from 2-channel sources and produces multi-channel sound (DTS Neo:6 Cinema/DTS Neo:6 Music mode decoding).

[2ch Stereo]: This system outputs the sound from the front left/right speakers and subwoofer only. Multi-channel surround formats are downmixed to 2-channel.



[Off]: The sound effects are disabled. You can hear sound as it is recorded.

---

### ■ [Speaker Settings]

To obtain optimum surround sound, set the speakers. For details, see “Setting the Speakers” (page 40).

---

### ■ [Bluetooth AUDIO - AAC]

You can enable and disable AAC audio.

[On]: AAC audio if the *Bluetooth* device supports AAC.

[Off]: SBC audio.

#### Note

You can enjoy high quality sound if the AAC is enabled. In case you cannot listen to AAC sound from your device, select [Off].

---

## [BD/DVD Viewing Settings]

---

### ■ [BD/DVD Menu Language]

You can select the default menu language for BD-ROMs or DVD VIDEOS.

When you select [Select Language Code], the display for entering the language code appears. Enter the code for your language by referring to “Language Code List” (page 66).

---

### ■ [Audio Language]

You can select the default track language for BD-ROMs or DVD VIDEOS.

When you select [Original], the language given priority in the disc is selected. When you select [Select Language Code], the display for entering the language code appears. Enter the code for your language by referring to “Language Code List” (page 66).

---

### ■ [Subtitle Language]

You can select the default subtitle language for BD-ROMs or DVD VIDEOS.

When you select [Select Language Code], the display for entering the language code appears. Enter the code for your language by referring to “Language Code List” (page 66).

---

### ■ [BD Hybrid Disc Playback Layer]

[BD]: Plays BD layer.

[DVD/CD]: Plays DVD or CD layer.

---

### ■ [BD Internet Connection]

[Allow]: Normally select this.

[Do not allow]: Prohibits Internet connection.

---

## [Parental Control Settings]

---

### ■ [Password]

Set or change the password for the Parental Control function. A password allows you to set a restriction on BD-ROM, DVD VIDEO, or Internet video playback. If necessary, you can differentiate the restriction levels for BD-ROMs and DVD VIDEOS.

---

### ■ [Parental Control Area Code]

Playback of some BD-ROMs or DVD VIDEOS can be limited according to the geographic area. Scenes may be blocked or replaced with different scenes. Follow the on-screen instructions and enter your four-digit password.

---

### ■ [BD Parental Control]/[DVD Parental Control]/[Internet Video Parental Control]

By setting Parental Control, scenes can be blocked or replaced with different scenes. Follow the on-screen instructions and enter your four-digit password.

---

### ■ [Internet Video Unrated]

[Allow]: Allows the playback of unrated Internet videos.

[Block]: Blocks the playback of unrated Internet videos.

---



---

## [System Settings]

---

### ■ [OSD Language]

You can select the language you want for the system on-screen display.

---

### ■ [Main Unit illumination]

[On]: The front panel display is always turned on and the brightness of the LED indicator is the maximum.

[Auto]: The front panel display is turned off and the brightness of LED indicator is reduced automatically if you do not operate the system for about 10 seconds.

---

### ■ [HDMI Settings]

[Control for HDMI]

[On]: Turns on the [Control for HDMI] function. You can operate mutually between equipment that are connected with an HDMI cable.

[Off]: Off.

---

[Audio Return Channel]

This function is available when you connect the system to a TV's HDMI IN jack that is compatible with the Audio Return Channel function and [Control for HDMI] is set to [On].

[Auto]: The system can receive the digital audio signal of the TV automatically via an HDMI cable.

[Off]: Off.

---

### ■ [Quick Start Mode]

[On]: Shortens the startup time from standby mode. You can operate the system quickly after turning it on.

[Off]: The default setting.

---

### ■ [Auto Display]

[On]: Automatically displays information on the screen when changing the viewing titles, picture modes, audio signals, etc.

[Off]: Displays information only when you press DISPLAY.

---

### ■ [Screen Saver]

[On]: Turns on the screen saver function.

[Off]: Off.

---

### ■ [Software Update Notification]

[On]: Sets the system to inform you of latest software version information (page 46).

[Off]: Off.

---

### ■ [Gracenote Settings]

[Auto]: Automatically downloads disc information when you stop playback of the disc. To download, the system must be connected to the network.

[Manual]: Downloads disc information when [Video Search] or [Music Search] is selected.

---

---

### ■ [System Information]

You can display the system's software version information and the MAC address.

---

### ■ [Software License Information]

You can display the Software License Information.

---



---

## [Network Settings]

---

### ■ [Internet Settings]

Connect the system to the network beforehand. For details, see "Step 3: Preparing for Network Connection" (page 21).

[Wired Setup]: Select this when you connect to a broadband router using a LAN cable.

[Wireless Setup(built-in)]: Select this when you use the built-in wireless LAN of the system for wireless network connection.

#### Tip

For further details, visit the following website and check the FAQ:  
<http://www.sony.com/blurayhtsupport/>

---

### ■ [Network Connection Status]

Displays the current network connection status.

---

### ■ [Network Connection Diagnostics]

You can run the network diagnostic to check if the network connection has been made properly.

---

### ■ [Connection Server Settings]

Sets whether or not to display the connected DLNA server.

---

---

### ■ [Renderer Options]

[Auto Access Permission]: Sets whether or not to allow automatic access from a newly detected DLNA controller.

[Smart Select]: Allows a Sony DLNA controller to find the system as the target equipment to operate by using the infrared ray. You can set this function to on or off.

[Renderer Name]: Displays the system's name as it is listed on other DLNA devices on the network.

---

### ■ [Renderer Access Control]

Sets whether or not to accept commands from DLNA controllers.

---

### ■ [PARTY Auto Start]

[On]: Starts a PARTY or joins an existing PARTY at the request of a networked device compatible with the PARTY STREAMING function.

[Off]: Off.

---

### ■ [Registered Remote Devices]

Displays a list of your registered remote devices.

---

#### Note

To use this function, be sure to perform the software update (page 46).

---

### ■ [Remote Start]

[On]: Allows turn on the system by a device linked via network when the system is in standby mode.

[Off]: The system cannot be turned on by a device linked via network.

---



## 1-2-3 [Easy Network Settings]

Runs [Easy Network Settings] to make the basic network settings. Follow the on-screen instructions.



## [Resetting]

### ■ [Reset to Factory Default Settings]

You can reset the system settings to the factory default by selecting the group of settings. All the settings within the group will be reset.

### ■ [Initialize Personal Information]

You can erase your personal information stored in the system.

## Additional Information

## Precautions

### On safety

- Should any solid object or liquid fall into the cabinet, unplug the system and have it checked by qualified personnel before operating it any further.
- Do not touch the AC power cord (mains lead) with wet hands. Doing so may cause an electric shock.

### On power sources

If you are not going to use the system for a long time, be sure to disconnect the system from the wall outlet. To disconnect the AC power cord (mains lead), grasp the plug itself; never pull the cord.

### On placement

- Place the system in a location with adequate ventilation to prevent heat build-up in the system.
- Although the unit heats up during operation, this is not a malfunction. If you continuously use this unit at a large volume, the cabinet temperature of the top, side and bottom rises considerably. To avoid burning yourself, do not touch the cabinet.
- Do not place the unit on a soft surface (rugs, blankets, etc.) that might block the ventilation holes.
- Do not install the system near heat sources such as radiators, air ducts, or in a place subject to direct sunlight, excessive dust, mechanical vibration, or shock.
- Do not install the system in an inclined position. It is designed to be operated in a horizontal position only.

- Keep the system and discs away from components with strong magnets, such as microwave ovens, or large loudspeakers.
- Do not place heavy objects on the system.
- Do not place metal objects in front of the front panel. It may limit reception of radio waves.
- Do not place the system in a place where medical equipment is in use. It may cause a malfunction of medical equipment.
- If you use a pacemaker or other medical device, consult your physician or the manufacturer of your medical device before using the wireless LAN function.

### On operation

If the system is brought directly from a cold to a warm location, or is placed in a very damp room, moisture may condense on the lenses inside the unit. Should this occur, the system may not operate properly. In this case, remove the disc and leave the system turned on for about half an hour until the moisture evaporates.

### On adjusting volume

Do not turn up the volume while listening to a section with very low level inputs or no audio signals. If you do, the speakers may be damaged when a peak level section is suddenly played.

### On cleaning

Clean the cabinet, panel, and controls with a soft cloth slightly moistened with a mild detergent solution. Do not use any type of abrasive pad, scouring powder or solvent such as alcohol or benzine.

### On cleaning discs, disc/lens cleaners

**Do not use cleaning discs or disc/lens cleaners (including wet or spray types). These may cause the apparatus to malfunction.**

### On replacement of parts

In the events that this system is repaired, repaired parts may be retained for reuse or recycling purposes.

### On your TV's color

If the speakers cause the color irregularity on your TV screen, turn off the TV then turn it on after 15 to 30 minutes. If color irregularity persists, place the speakers further away from the TV set.

#### IMPORTANT NOTICE

Caution: This system is capable of holding a still video image or on-screen display image on your TV screen indefinitely. If you leave the still video image or on-screen display image displayed on your TV for an extended period of time, you risk permanent damage to your TV screen. Plasma display panel televisions and projection televisions are especially susceptible to this.

### On moving the system

Before moving the system, make sure that there is no disc inserted, and disconnect the AC power cord (mains lead) from the wall outlet (mains).

## On Bluetooth communication

- *Bluetooth* devices should be used within approximately 10 meters (33 feet) (unobstructed distance) of each other. The effective communication range may become shorter under the following conditions.
  - When a person, metal object, wall or other obstruction is between the devices with a *Bluetooth* connection
  - Locations where a wireless LAN is installed
  - Around microwave ovens that are in use
  - Locations where other electromagnetic waves occur
- *Bluetooth* devices and wireless LAN (IEEE 802.11b/g) use the same frequency band (2.4 GHz). When using your *Bluetooth* device near a device with wireless LAN capability, electromagnetic interference may occur. This could result in lower data transfer rates, noise, or inability to connect. If this happens, try the following remedies:
  - Use this unit at least 10 meters (33 feet) away from the wireless LAN device.
  - Turn off the power to the wireless LAN equipment when using your *Bluetooth* device within 10 meters (33 feet).
  - Install this unit and *Bluetooth* device as closer to each other as possible.
- The radio waves broadcast by this unit may interfere with the operation of some medical devices. Since this interference may result in malfunction, always turn off the power on this unit and *Bluetooth* device in the following locations:
  - In hospitals, on trains, in airplanes, at gas stations, and any place where flammable gasses may be present
  - Near automatic doors or fire alarms
- This unit supports security functions that comply with the *Bluetooth* specification to ensure secure connection during communication using *Bluetooth* technology. However, this security may be insufficient depending on the setting contents and other factors, so always be careful when performing communication using *Bluetooth* technology.
- Sony cannot be held liable in any way for damages or other loss resulting from information leaks during communication using *Bluetooth* technology.
- *Bluetooth* communication is not necessarily guaranteed with all *Bluetooth* devices that have the same profile as this unit.
- *Bluetooth* devices connected with this unit must comply with the *Bluetooth* specification prescribed by the Bluetooth SIG, Inc., and must be certified to comply. However, even when a device complies with the *Bluetooth* specification, there may be cases where the characteristics or specifications of the *Bluetooth* device make it impossible to connect, or may result in different control methods, display or operation.
- Noise may occur or the audio may cut off depending on the *Bluetooth* device connected with this unit, the communications environment, or surrounding conditions.

If you have any questions or problems concerning your system, please consult your nearest Sony dealer.

## Notes about Discs

### On handling discs

- To keep the disc clean, handle the disc by its edge. Do not touch the surface.
- Do not stick paper or tape on the disc.



- Do not expose the disc to direct sunlight or heat sources such as hot air ducts, or leave it in a car parked in direct sunlight as the temperature may rise considerably inside the car.
- After playing, store the disc in its case.

### On cleaning

- Before playing, clean the disc with a cleaning cloth. Wipe the disc from the center out.



- Do not use solvents such as benzene, thinner, commercially available cleaners, or anti-static spray intended for vinyl LPs.

This system can only play a standard circular disc. Using neither standard nor circular discs (e.g., card, heart, or star shape) may cause a malfunction.

Do not use a disc that has a commercially available accessory attached, such as a label or ring.

## Troubleshooting

If you experience any of the following difficulties while using the system, use this troubleshooting guide to help remedy the problem before requesting repairs. Should any problem persist, consult your nearest Sony dealer.

### General



#### The power does not turn on.

- Check that the AC power cord (mains lead) is connected securely.

#### The remote control does not function.

- The distance between the remote control and the unit is too far.
- The batteries in the remote control are weak.

#### The disc tray does not open and you cannot remove the disc even after you press .

- Try the following:
  - ① Hold down  and  on the unit for more than 5 seconds to open the disc tray.
  - ② Remove the disc.
  - ③ Disconnect the AC power cord (mains lead) from the wall outlet (mains), then reconnect after several minutes.

#### The system does not work normally.

- Disconnect the AC power cord (mains lead) from the wall outlet (mains), then reconnect after several minutes.

## Messages

**[A new software version is available. Please go to the “Setup” section of the menu and select “Network Update” to perform the update.] appears on the TV screen.**

→ See [Network Update] (page 46) to update the system to a latest software version.

**“PRTECT”, “PUSH” and “POWER” appear alternately in the front panel display.**

→ Press  to turn off the system, and check the following items after “STBY” disappears.

- Are you using only the supplied speakers?
- Is anything blocking the ventilation holes of the system?
- After checking the above items and fixing any problems, turn on the system. If the cause of the problem cannot be found even after checking all the above items, consult your nearest Sony dealer.

**“LOCKED” appears in the front panel display.**

→ Set the child lock function to off (page 42).

**“D. LOCK” appears in the front panel display.**

→ Contact your nearest Sony dealer or local authorized Sony service facility.

**“Exxxx” (x is a number) appears in the front panel display.**

→ Contact your nearest Sony dealer or local authorized Sony service facility and give the error code.

 **appears without any messages on the entire TV screen.**

→ Contact your nearest Sony dealer or local authorized Sony service facility.

## Picture

**There is no picture or the picture is not output correctly.**

→ Check the output method on your system (page 19).

→ Hold down  and VOL – on the unit for more than 5 seconds to reset the video output resolution to the lowest resolution.

→ For BD-ROMs, check the [BD-ROM 24p Output] settings in [Screen Settings] (page 47).

**There is no picture when you make an HDMI cable connection.**

→ The unit is connected to an input device that is not HDCP (High-bandwidth Digital Content Protection) compliant (“HDMI” in the front panel does not light up) (page 19).

**The dark area of the picture is too dark/the bright area is too bright or unnatural.**

→ Set [Picture Quality Mode] to [Standard] (default) (page 36).

**Picture noise appears.**

→ Clean the disc.

→ If the picture output from your system goes through your equipment to get to your TV, the copy-protection signal applied to some BD/DVD programs could affect picture quality. If you still experience problems even when you connect your unit directly to your TV, try connecting your unit to the other input jacks.



**An image is not displayed on the entire TV screen.**

- Check the setting of [TV Type] in [Screen Settings] (page 46).
- The aspect ratio on the disc is fixed.

**Color irregularity occurs on the TV screen.**

- If the speakers are used with a CRT-based TV or projector, install the speakers at least 0.3 meters (1 foot) from the TV set.
- If the color irregularity persists, turn off the TV set once, then turn it on after 15 to 30 minutes.
- Make sure that no magnetic object (magnetic latch on a TV stand, health care device, toy, etc.) is placed near the speakers.

**Sound****There is no sound.**

- The speaker cords are not connected securely.
- Check the speaker settings (page 40).

**There is no sound from the TV via the HDMI (OUT) jack when using the Audio Return Channel function.**

- Set [Control for HDMI] in [HDMI Settings] of [System Settings] to [On] (page 50). Also, set [Audio Return Channel] in [HDMI Settings] of [System Settings] to [Auto] (page 50).
- Make sure that your TV is compatible with the Audio Return Channel function.
- Make sure that an HDMI cable is connected to a jack on your TV that is compatible with the Audio Return Channel function.

**The system does not output sound of TV programs correctly when connected to a set-top box.**

- Set [Audio Return Channel] in [HDMI Settings] of [System Settings] to [Off] (page 50).
- Check the connections (page 20).

**Severe hum or noise is heard.**

- Move your audio equipment away from the TV.
- Clean the disc.

**The sound loses stereo effect when you play a CD.**

- Select stereo sound by pressing AUDIO (page 37).

**The sound outputs from the center speaker only.**

- Depending on the disc, the sound may output from the center speaker only.

**No sound or only a very low-level sound is heard from the surround speakers.**

- Check the speaker connections and settings (pages 18, 40).
- Check the sound mode setting (page 24).
- Depending on the source, the effect of the surround speakers may be less noticeable.
- A 2-channel source is being played.

**Distortion occurs in the sound of a connected equipment.**

- Reduce the input level for the connected equipment by setting [Attenuate - AUDIO] (page 48).

**A sudden loud music is heard.**

- The build-in sound demonstration is activated. Press VOL - to reduce the volume or press ■ to stop the demonstration.

## Tuner

### Radio stations cannot be tuned in.

- Check that the antenna (aerial) is connected securely. Adjust the antenna (aerial).
- The signal strength of the stations is too weak (when tuning in with automatic tuning). Use manual tuning.

## Playback

### The disc does not play.

- The region code on the BD/DVD does not match the system.
- Moisture has condensed inside the unit and may cause damage to the lenses. Remove the disc and leave the unit turned on for about half an hour.
- The system cannot play a recorded disc that is not correctly finalized (page 60).

### File names are not displayed correctly.

- The system can only display ISO 8859-1 compliant character formats. Other character formats may be displayed differently.
- Depending on the writing software used, the input characters may be displayed differently.

### A disc does not start playing from the beginning.

- Resume play has been selected. Press **OPTIONS** and select [Play from beginning], then press **(+)**.

### Playback does not start from the resume point where you last stopped playing.

- The resume point may be cleared from memory depending on the disc when
  - you open the disc tray.
  - you disconnect the USB device.
  - you play other content.
  - you turn off the unit.

### The language for the soundtrack/subtitle or angles cannot be changed.

- Try using the BD's or DVD's menu.
- Multi-lingual tracks/subtitles or multi-angles are not recorded on the BD or DVD being played.

### Bonus contents or other data that are contained in a BD-ROM cannot be played.

- Try the following:
  - ① Remove the disc.
  - ② Turn the system off.
  - ③ Remove and reconnect the USB device (page 28).
  - ④ Turn the system on.
  - ⑤ Insert the BD-ROM with BONUSVIEW/BD-LIVE.

## USB device

### The USB device is not recognized.

- Try the following:
  - ① Turn the system off.
  - ② Remove and reconnect the USB device.
  - ③ Turn the system on.
- Make sure that the USB device is securely connected to the  (USB) port.
- Check if the USB device or a cable is damaged.
- Check if the USB device is on.

- If the USB device is connected via a USB hub, disconnect it and connect the USB device directly to the unit.

## **BRAVIA Internet Video**

**The picture/sound is poor/certain programs display with a loss of detail, especially during fast-motion or dark scenes.**

- Picture/sound quality may be poor depending on Internet content providers.
- Picture/sound quality may be improved by changing the connection speed. Sony recommends a connection speed of at least 2.5 Mbps for standard-definition video and 10 Mbps for high-definition video.
- Not all videos contain sound.

**The picture is small.**

- Press **▲** to zoom in.

## **“BRAVIA” Sync ([Control for HDMI])**

**The [Control for HDMI] function does not work (“BRAVIA” Sync).**

- Check that [Control for HDMI] is set to [On] (page 50).
- If you change the HDMI connection, turn the system off and on again.
- If power failure occurs, set [Control for HDMI] to [Off], then set [Control for HDMI] to [On] (page 50).
- Check the following and refer to the operating instructions supplied with the equipment.
  - The connected equipment is compatible with the [Control for HDMI] function.

- The connected equipment’s setting for the [Control for HDMI] function is correct.

## **Network connection**

**The system cannot connect to the network.**

- Check the network connection (page 21) and the network settings (page 51).

## **Wireless LAN connection**

**You cannot connect your PC to the Internet after [Wi-Fi Protected Setup (WPS)] is performed.**

- The wireless settings of the router may change automatically if you use the Wi-Fi Protected Setup function before adjusting the settings of the router. In this case, change the wireless settings of your PC accordingly.

**The system cannot connect to the network or the network connection is unstable.**

- Check if the wireless LAN router is on.
- Check the network connection (page 21) and the network settings (page 51).
- Depending on the usage environment, including the wall material, radio wave reception conditions, or obstacles between the system and the wireless LAN router, the possible communication distance may be shortened. Move the system and the wireless LAN router closer to each other.

- Devices that use a 2.4 GHz frequency band, such as a microwave, *Bluetooth*, or digital cordless device, may interrupt communication. Move the unit away from such devices, or turn off such devices.
- The wireless LAN connection may be unstable depending on the usage environment, especially while using the *Bluetooth* function of the system. In this case, adjust the usage environment.

### The wireless router you want is not shown in the wireless network list.

- Press RETURN to return to the previous screen, and try [Wireless Setup(built-in)] again. If the wireless router you want is still not detected, select [Add a new address.] from the network list, then select [Manual Registration] to input a network name (SSID) manually.

## Bluetooth device

### Pairing cannot be done.

- Move the *Bluetooth* device closer to the unit.
- Pairing may not be possible if other *Bluetooth* devices are present around the unit. In this case, turn off the other *Bluetooth* devices.
- Delete the system from your *Bluetooth* device and perform pairing again (page 29).

### Connecting cannot be done.

- The pairing registration information has been erased. Perform the pairing operation again (page 29).

### There is no sound.

- Make sure this system is not too far from the *Bluetooth* device, or this system is not receiving interference from a Wi-Fi network, other 2.4 GHz wireless device, or microwave oven.
- Check that the *Bluetooth* connection is made properly between this system and the *Bluetooth* device.
- Pair this system and the *Bluetooth* device again.
- Keep the system away from metal objects or surfaces.
- Make sure "BT" function is selected.
- Adjust the volume of the *Bluetooth* device first, if the volume level is still too low, adjust the volume level on the unit.

### The sound skips or fluctuates, or the connection is lost.

- The unit and the *Bluetooth* device are too far apart.
- If there are obstacles between the unit and your *Bluetooth* device, remove or avoid the obstacles.
- If there is equipment that generates electromagnetic radiation, such as a wireless LAN, other *Bluetooth* device, or a microwave oven nearby, move them away.

## Playable Discs

<b>Blu-ray Disc</b>	BD-ROM <sup>1)</sup> BD-R/BD-RE <sup>2)</sup>
<b>DVD<sup>3)</sup></b>	DVD-ROM DVD-R/DVD-RW DVD+R/DVD+RW
<b>CD<sup>3)</sup></b>	CD-DA (Music CD) CD-ROM CD-R/CD-RW

<sup>1)</sup> Since Blu-ray Disc specifications are new and evolving, some discs may not be playable depending on the disc type and version. Also, the audio output differs depending on the source, connected output jack, and selected audio settings.

<sup>2)</sup> BD-RE: Ver.2.1

BD-R: Ver.1.1, 1.2, 1.3 including organic pigment type BD-R (LTH type)  
BD-Rs recorded on a PC cannot be played if postscripts are recordable.

<sup>3)</sup> A CD or DVD disc will not play if it has not been correctly finalized. For more information, refer to the operating instructions supplied with the recording device.

## Discs that cannot be played

- BDs with cartridge
- BDXLs
- DVD-RAMs
- HD DVDs
- DVD Audio discs
- PHOTO CDs
- Data part of CD-Extras
- Super VCDs
- Audio material side on DualDiscs
- For U.S.A. and Canada models: A disc recorded in a color system other than NTSC, such as PAL (This system conforms to the NTSC color system.)

## Notes on discs

This product is designed to play back discs that conform to the Compact Disc (CD) standard.

DualDiscs and some music discs encoded with copyright protection technologies do not conform to the Compact Disc (CD) standard. Therefore, these discs may not be compatible with this product.

## Note on playback operations of a BD/DVD

Some playback operations of a BD/DVD may be intentionally set by software producers. Since this system plays a BD/DVD according to the disc contents the software producers designed, some playback features may not be available.

## Note on double-layer BDs/DVDs

The playback picture and sound may be momentarily interrupted when the layers switch.

## Region code (BD-ROM/DVD VIDEO only)

Your system has a region code printed on the bottom of the unit and will only play a BD-ROM/DVD VIDEO (playback only) labeled with identical region codes or .

## Playable Types of Files

### Video

Video Codec	Container	Extension
MPEG-1 Video <sup>*1</sup>	PS	.mpg, .mpeg
MPEG-2 Video <sup>*2</sup>	PS <sup>*3</sup>	.mpg, .mpeg
	TS <sup>*4</sup>	.m2ts, .mts
Xvid	AVI	.avi
	MKV	.mkv
MPEG4/AVC <sup>*5</sup>	MKV <sup>*1</sup>	.mkv
	MP4 <sup>*1</sup>	.mp4, .m4v
	TS <sup>*1</sup>	.m2ts, .mts
	Quick Time <sup>*6</sup>	.mov
	3gpp/ 3gpp2 <sup>*6</sup>	.3gp, .3g2, .3gpp, .3gp2
VC1 <sup>*1</sup>	TS	.m2ts, .mts
WMV9 <sup>*1</sup>	ASF	.wmv, .asf
Motion JPEG <sup>*6</sup>	Quick Time	.mov
	AVI	.avi

Video Format	Container	Extension
AVCHD <sup>*1*7</sup>	AVCHD Format Folder <sup>*8</sup>	

## Music

Audio Codec	Extension
MP3 (MPEG-1 Audio Layer III)	.mp3, .mka <sup>*6</sup>
AAC <sup>*1</sup>	.m4a, .aac <sup>*6</sup> , .mka <sup>*6</sup>
WMA9 Standard <sup>*1</sup>	.wma
LPCM	.wav, .mka <sup>*6</sup>
FLAC <sup>*6</sup>	.flac, .fla
AC3 <sup>*6</sup>	.ac3, .mka

## Photo

Photo Format	Extension
JPEG	.jpeg, .jpg, .jpe
PNG	.png <sup>*9</sup>
GIF	.gif <sup>*9</sup>
MPO	.mpo <sup>*6*10</sup>

<sup>\*1</sup> The system may not play this file format on a DLNA server.

<sup>\*2</sup> The system can only play standard definition video on a DLNA server.

<sup>\*3</sup> The system does not play DTS format files on a DLNA server.

<sup>\*4</sup> The system can only play Dolby Digital format files on a DLNA server.

<sup>\*5</sup> The system can support AVC up to Level 4.1.

<sup>\*6</sup> The system does not play this file format on a DLNA server.

<sup>\*7</sup> The system can play AVCHD Ver.2.0 format (AVCHD 3D/Progressive).

<sup>\*8</sup> The system plays AVCHD format files that are recorded on a digital video camera, etc. The AVCHD format disc will not play if it has not been correctly finalized.

<sup>\*9</sup> The system does not play animated PNG or animated GIF files.

<sup>\*10</sup> For MPO files other than 3D, the key image or the first image is displayed.

### Note

- Some files may not play depending on the file format, the file encoding, the recording condition, or DLNA server condition.
- Some files edited on a PC may not play.
- Some files may not be able to perform fast forward or fast reverse function.
- The system does not play coded files such as DRM and Lossless.
- The system can recognize the following files or folders in BDs, DVDs, CDs and USB devices:
  - up to folders in the 9th layer (including the root folder)
  - up to 500 files/folders in a single layer
- The system can recognize the following files or folders stored in the DLNA server:
  - up to folders in the 19th layer
  - up to 999 files/folders in a single layer
- The system can support frame rate:
  - up to 60 fps for AVCHD only.
  - up to 30 fps for other video codecs.
- The system can support video bit rate up to 40 Mbps.
- The system can support video resolution up to 1920 × 1080p.
- Some USB devices may not work with this system.
- The system can recognize Mass Storage Class (MSC) devices (such as flash memory or an HDD), Still Image Capture Devices (SICDs), and 101-key keyboards.
- The system may not play high bit rate video files from a DATA CD smoothly. It is recommended to play high bit rate video files using a DATA DVD or DATA BD.

## Supported Audio Formats

Audio formats supported by this system are as follows.

Format	Function	
	“BD/DVD”	“TV” (DIGITAL IN)
LPCM 2ch	○	○
LPCM 5.1ch, LPCM 7.1ch	○	–
Dolby Digital	○	○
Dolby TrueHD, Dolby Digital Plus	○	–
DTS	○	○
DTS-ES Discrete 6.1, DTS-ES Matrix 6.1	○*	○*
DTS96/24	○	○*
DTS-HD High Resolution Audio	○	–
DTS-HD Master Audio	○	–

○: Supported format.

–: Unsupported format.

\* Decoded as DTS core.

### Note

For LPCM 2ch format, the supported sampling frequency of the digital signal is up to 48 kHz when using the “TV” function.

## Specifications

### Amplifier Section

#### U.S.A. model only:

#### AUDIO POWER SPECIFICATIONS

#### POWER OUTPUT AND TOTAL

#### HARMONIC DISTORTION:

(FTC)

Front L + Front R:

With 3 ohms loads, both channels driven, from 180 Hz – 20,000 Hz; rated 50 watts per channel minimum RMS power, with no more than 1% total harmonic distortion from 250 milliwatts to rated output.

#### Other models:

POWER OUTPUT (rated)

Front L/Front R:

75 W + 75 W (at 3 ohms, 1 kHz,  
1% THD)

POWER OUTPUT (reference)

Front L/Front R/Surround L/Surround R:

125 W (per channel at 3 ohms, 1 kHz)

Center:

250 W (at 6 ohms, 1 kHz)

Subwoofer:

250 W (at 6 ohms, 80 Hz)

Inputs (Analog)

AUDIO IN

Sensitivity: 1 V/400 mV

Inputs (Digital)

TV (Audio Return Channel/OPTICAL)

Supported formats: LPCM 2CH (up to  
48 kHz), Dolby Digital, DTS

### HDMI Section

Connector

Type A (19pin)

### BD/DVD/CD System

Signal format system

NTSC

### USB Section

USB (USB) port:

Type A (For connecting USB memory,  
memory card reader, digital still camera,  
and digital video camera)

## LAN Section

LAN (100) terminal  
100BASE-TX Terminal

## Wireless LAN Section

### Blu-ray Disc/DVD receiver (HBD-E6100/HBD-E4100/ HBD-E3100/HBD-E2100)

Standards Compliance  
IEEE 802.11 b/g/n  
Frequency and Channel  
2.4 GHz band: channels 1–11

## Bluetooth Section

Communication system  
*Bluetooth* Specification version 3.0  
Output  
*Bluetooth* Specification Power Class 2  
Maximum communication range  
Line of sight approx. 10 m (33 ft)<sup>1)</sup>  
Frequency band  
2.4 GHz band  
Modulation method  
FHSS (Freq Hopping Spread Spectrum)  
Compatible *Bluetooth* profiles<sup>2)</sup>  
A2DP 1.2 (Advanced Audio Distribution Profile)  
AVRCP 1.3 (Audio Video Remote Control Profile)  
Supported Codecs<sup>3)</sup>  
SBC<sup>4)</sup>, AAC  
Transmission range (A2DP)  
20 Hz – 20,000 Hz (Sampling frequency  
44.1 kHz, 48 kHz)

<sup>1)</sup>The actual range will vary depending on factors such as obstacles between devices, magnetic fields around a microwave oven, static electricity, cordless phone, reception sensitivity, antenna's performance, operating system, software application, etc.

<sup>2)</sup>*Bluetooth* standard profiles indicate the purpose of *Bluetooth* communication between devices.

<sup>3)</sup>Codec: Audio signal compression and conversion format

<sup>4)</sup>Subband Codec

## FM Tuner Section

System  
PLL quartz-locked digital synthesizer  
Tuning range  
87.5 MHz – 108.0 MHz (100 kHz step)  
Antenna (aerial)  
FM wire antenna (aerial)

## Speakers

### Front/Surround (SS-TSB123) for BDV-E6100

#### Front (SS-TSB123) for BDV-E4100

Dimensions (w/h/d) (approx.)  
100 mm × 650 mm × 100 mm (4 in ×  
25 5/8 in × 4 in) (wall-mounted part)  
260 mm × 1,200 mm × 260 mm  
(10 1/4 in × 47 1/4 in × 10 1/4 in) (whole  
speaker)  
Mass (approx.)  
Front: 1.3 kg (2 lb 14 oz) (wall-mounted  
part with speaker cord)  
2.9 kg (6 lb 7 oz) (whole speaker)  
Surround: 1.4 kg (3 lb 2 oz)  
(wall-mounted part with  
speaker cord)  
3.0 kg (6 lb 10 oz) (whole  
speaker)

### Front/Surround (SS-TSB122) for BDV-E3100

#### Surround (SS-TSB122) for BDV-E4100

Dimensions (w/h/d) (approx.)  
90 mm × 205 mm × 91 mm (3 5/8 in ×  
8 1/8 in × 3 5/8 in)  
Mass (approx.)  
Front: 0.53 kg (1 lb 3 oz) (with speaker  
cord)  
Surround: 0.62 kg (1 lb 6 oz) (with  
speaker cord)

### Front/Surround (SS-TSB121) for BDV-E2100

Dimensions (w/h/d) (approx.)  
95 mm × 189 mm × 80 mm (3 3/4 in ×  
7 1/2 in × 3 1/4 in)  
Mass (approx.)  
Front: 0.49 kg (1 lb 2 oz) (with speaker  
cord)  
Surround: 0.54 kg (1 lb 4 oz) (with  
speaker cord)



**Center (SS-CTB122) for BDV-E6100/  
BDV-E4100/BDV-E3100**

Dimensions (w/h/d) (approx.)

240 mm × 90 mm × 85 mm (9 1/2 in ×  
3 5/8 in × 3 3/8 in)

Mass (approx.)

0.58 kg (1 lb 5 oz) (with speaker cord)

**Center (SS-CTB121) for BDV-E2100**

Dimensions (w/h/d) (approx.)

225 mm × 84 mm × 75 mm (8 7/8 in ×  
3 3/8 in × 3 in)

Mass (approx.)

0.5 kg (1 lb 2 oz) (with speaker cord)

**Subwoofer (SS-WSB123) for  
BDV-E6100/BDV-E4100/BDV-E3100**

Dimensions (w/h/d) (approx.)

225 mm × 365 mm × 345 mm (8 7/8 in ×  
14 3/8 in × 13 5/8 in)

Mass (approx.)

5.8 kg (12 lb 13 oz) (with speaker cord)

**Subwoofer (SS-WSB122) for  
BDV-E2100**

Dimensions (w/h/d) (approx.)

220 mm × 305 mm × 255 mm (8 3/4 in ×  
12 1/8 in × 10 1/8 in)

Mass (approx.)

3.8 kg (8 lb 7 oz) (with speaker cord)

**General**

Power requirements

120 V AC, 60 Hz

Power consumption

On: 95 W

Standby: 0.3 W (For details on the  
setting, see page 43.)

Dimensions (w/h/d) (approx.)

430 mm × 50.5 mm × 296 mm (17 in ×  
2 in × 11 3/4 in) incl. projecting parts

Mass (approx.)

2.7 kg (5 lb 16 oz)

Design and specifications are subject to  
change without notice.

- Standby power consumption: 0.3W
- Over 85% power efficiency of amplifier block is achieved with the full digital amplifier, S-Master.

# Language Code List

The language spellings conform to the ISO 639: 1988 (E/F) standard.

Code	Language	Code	Language	Code	Language	Code	Language
1027	Afar	1183	Irish	1347	Maori	1507	Samoan
1028	Abkhazian	1186	Scots Gaelic	1349	Macedonian	1508	Shona
1032	Afrikaans	1194	Galician	1350	Malayalam	1509	Somali
1039	Amharic	1196	Guarani	1352	Mongolian	1511	Albanian
1044	Arabic	1203	Gujarati	1353	Moldavian	1512	Serbian
1045	Assamese	1209	Hausa	1356	Marathi	1513	Siswati
1051	Aymara	1217	Hindi	1357	Malay	1514	Sesotho
1052	Azerbaijani	1226	Croatian	1358	Maltese	1515	Sundanese
1053	Bashkir	1229	Hungarian	1363	Burmese	1516	Swedish
1057	Byelorussian	1233	Armenian	1365	Nauru	1517	Swahili
1059	Bulgarian	1235	Interlingua	1369	Nepali	1521	Tamil
1060	Bihari	1239	Interlingue	1376	Dutch	1525	Telugu
1061	Bislama	1245	Inupiak	1379	Norwegian	1527	Tajik
1066	Bengali;	1248	Indonesian	1393	Occitan	1528	Thai
	Bangla	1253	Icelandic	1403	(Afan)Oromo	1529	Tigrinya
1067	Tibetan	1254	Italian	1408	Oriya	1531	Turkmen
1070	Breton	1257	Hebrew	1417	Punjabi	1532	Tagalog
1079	Catalan	1261	Japanese	1428	Polish	1534	Setswana
1093	Corsican	1269	Yiddish	1435	Pashto;	1535	Tonga
1097	Czech	1283	Javanese		Pushto	1538	Turkish
1103	Welsh	1287	Georgian	1436	Portuguese	1539	Tsonga
1105	Danish	1297	Kazakh	1463	Quechua	1540	Tatar
1109	German	1298	Greenlandic	1481	Rhaeto-	1543	Twi
1130	Bhutani	1299	Cambodian		Romance	1557	Ukrainian
1142	Greek	1300	Kannada	1482	Kirundi	1564	Urdu
1144	English	1301	Korean	1483	Romanian	1572	Uzbek
1145	Esperanto	1305	Kashmiri	1489	Russian	1581	Vietnamese
1149	Spanish	1307	Kurdish	1491	Kinyarwanda	1587	Volapük
1150	Estonian	1311	Kirghiz	1495	Sanskrit	1613	Wolof
1151	Basque	1313	Latin	1498	Sindhi	1632	Xhosa
1157	Persian	1326	Lingala	1501	Sangho	1665	Yoruba
1165	Finnish	1327	Laothian	1502	Serbo-Croatian	1684	Chinese
1166	Fiji	1332	Lithuanian	1503	Singhalese	1697	Zulu
1171	Faroese	1334	Latvian;	1505	Slovak		
1174	French		Lettish	1506	Slovenian		
1181	Frisian	1345	Malagasy			1703	Not specified

## Parental Control/Area Code List

Code	Area	Code	Area	Code	Area	Code	Area
2044	Argentina	2109	Germany	2362	Mexico	2499	Sweden
2047	Australia	2200	Greece	2376	Netherlands	2086	Switzerland
2046	Austria	2219	Hong Kong	2390	New Zealand	2543	Taiwan
2057	Belgium	2248	India	2379	Norway	2528	Thailand
2070	Brazil	2238	Indonesia	2427	Pakistan	2184	United Kingdom
2090	Chile	2239	Ireland	2424	Philippines		
2092	China	2254	Italy	2428	Poland		
2093	Colombia	2276	Japan	2436	Portugal		
2115	Denmark	2304	Korea	2489	Russia		
2165	Finland	2333	Luxembourg	2501	Singapore		
2174	France	2363	Malaysia	2149	Spain		

# Index

## Numerics

- 3D 27
- 3D Output Setting 46

## A

- A/V SYNC 37
- Attenuate - AUDIO 48
- Audio DRC 48
- Audio Language 49
- Audio Output 48
- Audio Return Channel 50
- Audio Settings 48
- Auto Display 50

## B

- BD Audio MIX Setting 48
- BD Hybrid Disc Playback Layer 49
- BD Internet Connection 49
- BD Parental Control 50
- BD/DVD Menu Language 49
- BD/DVD Viewing Settings 49
- BD-LIVE 26
- BD-ROM 24p Output 47
- Bluetooth* 28
- BONUSVIEW 26
- BRAVIA Sync 40

## C

- CD 60
- Child Lock 42
- Cinema Conversion Mode 47
- Connection Server Settings 51
- Control for HDMI 40, 50

## D

- DLNA 33, 51
- Dolby Digital 37
- DTS 37
- DVD 60
- DVD Aspect Ratio 47
- DVD Parental Control 50
- DVD-ROM 24p Output 47

## E

- Easy Network Settings 52
- Easy Setup 23

## F

- FM Mode 38
- Front panel 13
- Front panel display 14

## G

- Gracenote Settings 50

## H

- HDMI
  - YCbCr/RGB (HDMI) 47
- HDMI Deep Color Output 47

## I

- Initialize Personal Information 52
- Internet content 32
- Internet Settings 51
- Internet Video Parental Control 50
- Internet Video Unrated 50

## L

- Language Code List 66

## **M**

- Main Unit illumination 50
- Multiplex broadcast sound 38

## **N**

- Network Connection Diagnostics 51
- Network Settings 51
- Network Update 46
- NFC 30

## **O**

- OSD Language 50

## **P**

- Parental Control Area Code 49
- Parental Control Settings 49
- PARTY Auto Start 51
- Password 49
- Pause Mode 48
- Play information 27
- Playable discs 60

## **Q**

- Quick Start Mode 50

## **R**

- Rear panel 14
- Region code 61
- Registered Remote Devices 51
- Remote control 15
- Remote Start 51
- Renderer Access Control 51
- Renderer Options 51
- Reset to Factory Default Settings 52
- Resetting 52

## **S**

- Screen Format 46
- Screen Saver 50
- Screen Settings 46
- SLEEP 42
- Slideshow 36
- Software License Information 51
- Sound Effect 48
- Speaker Settings 40, 49
  - Distance 41
  - Level 41
- Subtitle Language 49
- System Information 51

## **T**

- Test Tone 41
- TV Screen Size Setting for 3D 46
- TV Type 46

## **U**

- Update 46
- USB 28

## **W**

- WEP 22
- WPA2-PSK (AES) 22
- WPA2-PSK (TKIP) 22
- WPA-PSK (AES) 22
- WPA-PSK (TKIP) 22





The software of this system may be updated in the future. To find out details on any available updates, please visit the following URL.

<http://www.sony.com/blurayhtsupport/>

**HDMI**

**Blu-ray  
3D™**

 **gracenote.**

 **DLNA  
CERTIFIED™**

 **Blu-ray Disc™**

 **Java™  
POWERED**

<http://www.sony.net/>



\* 4 4 4 6 7 3 3 1 2 \* (1)